

English

29,1 - 30,4 t, 195 hp

**VOLVO EXCAVATOR**

# EC290C



**MORE CARE. BUILT IN.**

printed from [www.arag-bau.ch](http://www.arag-bau.ch)

**ARAG**  
*Baumaschinen-Rent*

ARAG Bau AG  
Zinggen  
6166 Hasle LU  
[www.arag-bau.ch](http://www.arag-bau.ch)  
Tel. 058 710 00 00



# VOLVO - A PARTNER TO TRUST.

Volvo wants you to trust your Volvo excavator. Volvo wants you to be comfortable while you work, so you can get more done. Volvo wants you to maximize profit through industry-leading fuel economy. Volvo delivered. It's all here in the Volvo EC290C Excavator and it meets all your wants, needs and jobsite requirements. Perfect for contractors, civil engineers and quarry companies, the Volvo EC290C excels in earth moving, road building, demolition and quarry work. It's everything you want and a whole lot more. You want a trusted partner, and this is it.

## **Your local partner around the globe**

Since 1927, Volvo has earned a global reputation for providing complete solutions. Volvo is built on core values of quality, safety and environmental care. The extensive line of construction equipment is augmented by Volvo's commercial transport solutions, including buses and trucks. This global experience and expertise have led to the ongoing development of engines with the lowest fuel consumption in their class. Today, the tradition continues with Volvo C-Series Excavators – designed and built to the exacting standards that make each machine a trusted Volvo partner.

## **Strong on quality, long on endurance**

Quality lasts. That is why Volvo is built to last with high quality throughout. The Volvo difference is clear, from the well-built cab details to the reinforced service doors to the rigid, long-life undercarriage.

If you have ever operated a Volvo Wheel Loader, Articulated Hauler or any of our machines, you know that Volvo is your edge for production, comfort and safety. Trust the Volvo EC290C Excavator to be ready to work – every day.

## **The innovators of comfort**

Volvo is known for legendary comfort, for less fatigue and higher productivity. The EC290C takes it to a whole new level of innovation with a larger, more ergonomic work environment. Visibility is better. So are the seat, floor space and access to controls/switches.

## **Leading fuel efficiency stretches profit**

Construction professionals around the world know Volvo for fuel efficiency – and the EC290C is set to remain the industry leader that gets the most out of each tank. Volvo: your most fuel-efficient option.

## **Experience for your work**

Get the job done in the excavator made for your work. From earth moving, 25-ton hauler loading and demolition to civil engineering, landfill work and utility/piping, the Volvo EC290C Excavator puts you in command.

## **The protection you need**

The Volvo EC290C's proven, long life booms and arms are ready for the toughest conditions. We've designed it and tested it to deliver strength and day after day endurance. Count on Volvo to help your business grow by getting the job done, making money and moving on to the next job. It has a maximum digging reach of 10,7 m, to a maximum depth of 7,3 m. And it's built to keep working day after day.



• Volvo: a sign of trust and quality.





• Reinforced boom/arm handles the jobs.



• Ideal reach and lift capacity.



• Intelligent command means greater profits.



• Efficient Volvo engine delivers high torque at very low RPMs.

- Reliable, reinforced boom and arm handle a variety of jobs with ease.
- Fast cycle times while excavating, loading and lifting are a result of an ideal combination of capacity, reach and force.
- Volvo high-tech toughness puts you comfortably in command of greater profits.
- Powerful Volvo V-ACT engine delivers proven performance and industry-leading fuel efficiency through high torque at low revs.

## VOLVO'S ENGINE LEADERSHIP SPANS LAND, SEA, SKY AND SPACE

As the world's largest manufacturer of 9-to-18-liter diesel engines, Volvo has unmatched expertise designing power systems that move the world. Volvo engines for Volvo Construction Equipment, Volvo

Aero, Volvo Buses, Volvo Penta and Volvo Trucks define productivity and fuel economy. Our performance has been honed on land, over the sea, across the sky and into space. Leading research and development

keeps all Volvo Group products at the forefront of productivity. So when we say Volvo engines are tested — and proven — you can believe it. Trust in it. It's the real advantage of Volvo Power.



# EASE INTO JOB SECURITY AND GET TO WORK.

At the beginning of each job, you try to figure out the best way to move the most material in the quickest, most effective manner. Volvo is with you, and one of the ways we do it is through industry-leading comfort and safety. It helps put your body and mind at ease so you can work longer and get more work done. The Volvo EC290C cab is now more roomy and comfortable. Take command in the seat of comfort. There's plenty of space for your feet. Experience excellent all-around visibility. Enjoy complete, full-body climate control. Less noise, more safety and harmony with the environment. It's the smart way to work.

## **Work with the ease of the comfortable cab**

Volvo is the innovative industry leader in comfort. More comfort means longer operation and increased productivity. The EC290C adjustable seat supports your whole body. The cab is wider and pedal positions have been shifted forward for more foot space. Find the correct joystick, seat and pedal position with forward/reverse and up/down adjustments. To reduce hazardous vibration, Volvo has gone beyond emerging regulations with a cab suspension system that greatly reduces whole body vibration.

## **Better all around command**

There's plenty of glazed surface for all around visibility. Volvo listened to operators and greatly expanded upper visibility. The roof hatch offers an optimal view during high-reach applications. The gas strut assisted windshield opens easily, while the smartly positioned windshield wiper cleans a wider area – including both upper corners. The easy-to-read LCD color monitor offers real-time information. The EC290C Volvo engine produces less noise and the pressurized, well-insulated cab blocks sound.

## **High-tech Volvo comfort**

The EC290C is the ultimate, modern work environment. Intelligently going beyond automobile technology, the EC290C's high-tech electronic climate control system comforts your entire body with the highest-capacity heating and cooling ventilation system available in the excavator industry.

## **Safe and protected**

The new-design Volvo Care Cab, with operator protective structure provides security. Volvo's attention to ergonomics when designing controls, pedals and monitors ensures safe, long-term use. An optional color rear view camera displaying on the LCD color monitor provides a safe view while slewing or travelling.

## **Anti-slip walk areas**

Outside the cab, all steps and platforms feature quality anti-slip traction with punched steel plates for superior grip – even when wet or icy. The bolt-on plates feature recessed bolts for less risk of trip hazard.

## **Environmental harmony**

More than 95% of the machine materials are recyclable. External sound levels have been greatly reduced for fewer disturbances. The machine's exterior paint is lead-free. Safely working in harmony with the people and environment around you is a core concern of Volvo.





- Expansive glass and clear sight lines provide outstanding all-around visibility with greater safety.
- Experience the adjustable suspension seat and take command of the jobsite.
- Intelligent new, easy-to-read LCD color monitor and perfectly positioned controls.
- All-new cab is larger and more comfortable with ergonomic controls and vibration dampening suspension for all-day production.
- Electronic climate control system distributes comfort evenly with 14 air vents and the highest-capacity heating and cooling available in the excavator industry.



• Experience the comfort of the suspension seat.



• Well-positioned monitor and controls.



• Greater floor space with larger pedals.



• Industry's highest heating/cooling capacity with 14 vents.

# GREATER ACCESS TO SERVICE, WORK & PROFITS.

Minimizing downtime. It can have one of the biggest impacts on your productivity and ultimately your profitability. The Volvo EC290C is built to maximize uptime. Maintenance is simple. Service access is complete. And to stay up and running, the EC290C is built for reliability with Volvo power, intelligent hydraulics, ideal capacity and a desire to handle every job in its path. In the trench, landfill, in the quarry or on the demolition site, the EC290C is right at home. Get one on your site and take home more of what you want: profit.

## **Volvo engine power and strength**

You want power and the EC290C has it. Experience the powerful new generation Stage IIIA compliant V-ACT (Volvo Advanced Combustion Technology) engine. It delivers 143 kW (195 hp) of optimized output with high engine torque at low revs, for ultra-efficient fuel consumption.

## **Innovative, advanced hydraulics**

The advanced hydraulic system will help you get more done – with the boom, arm and slew priority you demand. It's also highly responsive, for control that allows you to know exactly what to expect when you touch the joystick. In-cab operator-selectable hydraulic flow and pressure increases ease of attachment use and performance.

## **The perfect fit for your job**

In addition to the proven S-Type quick fit, the new optional universal quick fit with a proven design makes it easy to change attachments. Experience the Volvo edge with increased bucket speed, optional float position and a wide range of working modes that let you match requirements to the application, attachment and terrain.

## **The ease of service access**

The key to uptime is ease of service. The Volvo EC290C has simplified it. Ground level access makes inspection and service

quick and easy. Change the oil, fuel and water separator filters, as well as drain the oil and access the hydraulic pump – all from the ground. Inside the cab, quickly perform self-diagnostics through the color LCD monitor.

## **An edge in routine maintenance**

Get the most out of each day with ease of maintenance. The cab air filter is conveniently located outside the cab for easy replacement. Fuses are sealed and protected in a ground-accessible, steel box behind the cab. The sloped track frame design reduces build up of mud and debris.

## **Intelligent hydraulic oil cooler**

Fan speed is hydraulically (not engine) driven, intuitively sensing hydraulic oil/engine temperature and automatically activating to keep the system regulated at an optimized temperature. The result is less noise and lower fuel consumption. O-ring faced sealing is used in all hydraulic connections for added reliability. An anti-corrosive aluminium cooling module offers better heat dissipation and long life.

## **Common parts stretch profit**

You'll appreciate ease of parts availability, lower operating costs and over 100 components and consumable parts common to other Volvo machines you may run.







• Simplified, ground level service access.



• Easy access for hydraulic pump filters.



• Safe, anti-slip steps and platforms.



• More care built in through quality.

- Simplified, ground level service access, long service intervals and centralized lubrication points mean more uptime.
- Quick and easy access to hydraulic pumps and filters.
- Anti-slip, punched steel platforms and walk areas offer superior grip and safety.
- Intelligent, advanced hydraulic system balances available engine power with hydraulic output for smooth, responsive control.
- More uptime from well-protected hydraulic lines and easy-access grease points.



# RELIABILITY STARTS AND ENDS WITH QUALITY.

Perform your daily checks, climb in, turn the key and go to work. It may seem routine, but when you can count on it everyday and slice through the toughest of materials and conditions, you know you're working with Volvo reliability. Trust the Volvo EC290C. It's designed and built with more care and more quality. And Volvo dependability through quality is more than claims or mere words on paper. It's proven day after day, around the world, from the start to the end of every job. It's time to find out for yourself with the Volvo EC290C.

## **Quality is in the details**

You can see and feel the quality. It's in the rigid service doors, engine hood and protected electrical system. It's in the strengthened, high-tensile steel undercarriage frames, along with the reinforced booms and arms. It's in the reinforced superstructure with double welded corners and load-bearing boom frame. It's built for lower cost of ownership and higher resale value.

## **Grounded in durability**

The Volvo EC290C undercarriage and track are built for durability, reliability and stability. The lifetime greased sealed track link prevents grease leaks, reduces noise and guarantees longevity. A reinforced idler bracket prevents opening and track link derailing. For stability, the EC290C features an increased tumbler length.

## **Intelligent, high-tech toughness**

The Volvo EC290C isn't just tough, it's also intelligent and easy to operate. The machine's computer balances maximum available horsepower to hydraulic output, preventing engine overload – regardless of load on the pumps or engine speed. Volvo can do this because it's a Volvo engine, designed by Volvo engineers to specifically work with Volvo components.

## **Rely on your Volvo dealer for the support services you need:**

### **CareTrack helps track your machine**

CareTrack is an optional GPS monitoring program that works with the machine's diagnostic system. Installation is simple. You and your dealer can remotely track usage, productivity, fuel consumption and more. Maximize uptime through important service reminders. CareTrack also monitors geographic machine location and can even prevent unauthorized use. With CareTrack, you can focus on the care of your business while your Volvo dealer focuses on the care of your machine.

### **MATRIS gives you a full report**

MATRIS delivers detailed operating history analysis about the utilization and efficiency factors that influence your operating costs. MATRIS turns the data captured inside the machine's computer into easy-to-use graphs and reports. Check and correct operating techniques, reduce maintenance costs and increase service life.

### **PROSIS makes parts ordering faster**

PROSIS is a CD-ROM application that makes it quick and easy for your Volvo dealer to order all your Volvo CE product parts. Your dealer will help you find the right part, place your order and get you back up and running fast.







• Lifetime greased sealed track link.



• Your trust. Your satisfaction. Your edge.



• Optional protected arm with reinforced strip.



• Volvo is the partner you can grow with.

- Lifetime greased and sealed track link ensures long life.
- Your Volvo dealer is always there to help with parts, service and support.
- Optional protected arm with longer, reinforced strip and replaceable steel plates at both ends offers less wear and less expensive arm end maintenance.
- Reinforced, robotically-welded undercarriage frame distributes stress with rigid strength.
- Durable, standard undercover on the underside of the x-shaped frame provides extra protection.

# ADD SOMETHING EXTRA – TO YOUR BOTTOM LINE.

The Volvo EC290C Excavator is factory-ready to hit a wide range of jobsites in a wide range of industries. And if you want to customize your excavator specifically for your preferences or your work, you have lots of options. With Volvo optional equipment, you can add something extra, like some more comfort features or exterior protection. It can mean added machine versatility and, most importantly, added profit.

## **Hydraulic kits**

A wide variety of hydraulic kits is available for various boom and arm combinations. Each kit maximizes performance according to the machine's boom and arm length/shape. Get the most out of rotating/tilting attachments, crushers and hammers. Choose between 1 or 2 pump flow for best performance.

## **Hydraulic quick fit**

A Volvo hydraulic quick fit makes changing attachments quick and easy – all from the comfort and safety of the cab. Different quick fit types (universal and S-type) are available to fit new and existing customers' buckets/attachments.

## **Wrist control joysticks – proportional control**

Low-effort, wrist control joysticks provide smooth, precision control for increased comfort, efficiency and production. Wrist control joysticks with proportional control switches are also available.

## **Operator seats**

Volvo offers a wide variety of ergonomic operator seats designed specifically for comfort and protection. All seats, from various adjustable models to the most advanced air-suspension models, provide excellent support and are individually adjustable to suit operator preferences.

## **FOG and FOPS cab protection**

For added safety and protection, FOG (Falling Object Guard) and FOPS (Falling Object Protective Structure) certified cabs provide peace-of-mind for tough conditions such as quarries and demolition. The front guard of the FOG unit is tiltable and supported by a gas strut for easy front window cleaning. Both cab and frame-mounted FOG are available.

## **Straight travel pedal**

A pedal located by the left foot rest operates both travel motors at the same time, providing convenience when traveling and efficient work control in applications such as pipe laying.

## **Boom float function**

The boom float function lifts the boom over the ground without any pressure in the boom cylinders. Increases digging speed, cycle times and comfort of operation while working on rocky terrain. Reduces fuel consumption and wear. Effective for applications such as grading/finishing and grab work.

## **Extra work lights**

Extra work lights provide increased visibility, safety and precision, while extending the workday in low light conditions. Features two lights in the front of the machine, one light in the rear area of the cab and one light mounted on the counterweight.

## **Rear view camera**

For improved safety on the jobsite, the manually-operated camera provides a clear rear view when reverse travel is selected or to the right hand side of the superstructure when the slew function is activated. A clear display is visible on the wide screen, color LCD of the IECU (Instrument Electronic Control Unit). The protected camera can be switched manually, using a selection switch on the keypad, to show either rear or side view.

**To customize your excavator with other optional equipment features to suit your application, contact your local Volvo dealer.**





# VOLVO OPTIONAL EQUIPMENT



**Hydraulic kits**  
**Hydraulic quick fits**  
**Wrist control joysticks -  
 proportional control**

**Operator seats**  
**FOG and FOPS cab protection**  
**Straight travel pedal**

**Boom float function**  
**Extra work lights**  
**Rear view camera**

**NOTE:** Some features listed as optional equipment are standard equipment in some markets. Some equipment features listed are not available in all markets. Not a complete list of available optional equipment features. See included specification sheet for a complete listing.

# TAKE A TOUR. EXPERIENCE THE EC290C.

## MORE SAFETY

- **The new-design Volvo Care Cab**, with operator protective structure provides security.
- **Anti-slip steps and platforms** with punched steel plates for superior grip even when wet or icy.
- **Low engine emission levels and low noise.**
- **Increased tumbler length** ensures stability.
- **Recessed bolts on superstructure** walk areas for less risk of trip hazard.
- **Lead-free exterior paint** is in harmony with the environment.

## MORE PROFIT

- **New generation Volvo V-ACT engine:** powerful, innovative and efficient.
- Volvo continues to deliver **industry-leading fuel efficiency.**
- **Advanced hydraulic system** with priority functions and optional float position.
- **Optional universal quick fit** increases versatility.

## MORE COMFORT

- **New larger, more comfortable cab** puts you in command with ergonomic controls.
- **Roomy, adjustable seat** supports your whole body.





- **Top-mounted windshield wiper** cleans a wider area – including both upper corners.
- **Vibration dampening** protects against whole body fatigue for all-day productivity.
- **Electronic climate control system** delivers the highest-capacity heating and cooling available.



### **MORE UPTIME**

- **Simplified, ground level serviceability** means more uptime.
- **Easy access, centralized lubrication points.**
- **Easy-to-read LCD color monitor** for real-time information and trouble-shooting.
- **Easy to learn. Easy to operate. Easy to get more done.**

### **MORE QUALITY**

- **Strengthened undercarriage frame** endures daily abuse.
- **Reinforced boom/arm and proven components** deliver every time.
- **Reinforced superstructure** with double welded corners.
- **Lifetime greased, sealed track link** prevents leaks and guarantees long life.

# SPECIFICATIONS

## Engine

The next-generation Volvo diesel engine uses Volvo Advanced Combustion Technology (V-ACT) to deliver lower emissions and maintain superior performance and fuel efficiency. The EU Stage IIIA compliant engine uses precise, high-pressure fuel injectors, turbo charger and air to air intercooler and electronic engine controls to optimize machine performance.

<b>Engine</b>	Volvo D7E EAE3
<b>Max. power, at</b>	30 r/s (1 800 r/min)
<b>Net (ISO 9249, SAE J1349)</b>	143 kW (195 hp)
<b>Gross (SAE J1995)</b>	153 kW (208 hp)
<b>Max. torque at 1 350 r/min</b>	965 Nm
<b>No. of cylinders</b>	6
<b>Displacement</b>	7,14 l
<b>Bore</b>	108 mm
<b>Stroke</b>	130 mm

## Electrical system

High-capacity electrical system that is well protected. Waterproof double-lock harness plugs are used to secure corrosion-free connections. The main relays and solenoid valves are shielded to prevent damage. The master switch is standard.

<b>Voltage</b>	24 V
<b>Batteries</b>	2 x 12 V
<b>Battery capacity</b>	200 Ah
<b>Alternator</b>	28 V / 80 A

## Service refill capacities

<b>Fuel tank</b>	470 l
<b>Hydraulic system, total</b>	400 l
<b>Hydraulic tank</b>	195 l
<b>Engine oil</b>	30 l
<b>Engine coolant</b>	36 l
<b>Slew reduction unit</b>	11 l
<b>Travel reduction unit</b>	2 x 6,2 l

## Slew system

The slew system uses an axial piston motor, driving a planetary gearbox for maximum torque. An automatic holding brake and anti-rebound valve are standard.

<b>Max. slew speed</b>	10,2 r/min
<b>Max. slew torque</b>	104,3 kNm

## Drive

Each track is powered by an automatic two-speed shift travel motor. Track brakes are multi-disc, spring-applied and hydraulically released. The travel motor, brake and planetary gears are well protected within the track frame.

<b>Max. drawbar pull</b>	230,5 kN
<b>Max. travel speed</b>	3,3/5,2 km/h
<b>Gradeability</b>	35°

## Undercarriage

The undercarriage has a robust X-shaped frame. Greased and sealed track links are standard.

<b>Track pads</b>	2 x 50
<b>Link pitch</b>	203 mm
<b>Shoe width, triple grouser</b>	600/700/800/900 mm
<b>Shoe width, double grouser</b>	700 mm
<b>Bottom rollers</b>	2 x 9
<b>Top rollers</b>	2 x 2

## Hydraulic system

The hydraulic system, also known as the "Integrated work mode control" is designed for high-productivity, high-digging capacity, high-maneuvering precision and excellent fuel economy. The summation system, boom, arm and slew priority along with boom, arm and bucket regeneration provides optimum performance.

The following important functions are included in the system:

**Summation system:** Combines the flow of both hydraulic pumps to ensure quick cycle times and high productivity.

**Boom priority:** Gives priority to the boom operation for faster raising when loading or performing deep excavations.

**Arm priority:** Gives priority to the arm operation for faster cycle times in levelling and for increased bucket filling when digging.

**Slew priority:** Gives priority to slew functions for faster simultaneous operations.

**Regeneration system:** Prevents cavitation and provides flow to other movements during simultaneous operations for maximum productivity.

**Power boost:** All digging and lifting forces are increased.

**Holding valves:** Boom and arm holding valves prevent the digging equipment from creeping.

## Main pump:

Type: 2 x variable displacement axial piston pumps  
Maximum flow: 2 x 250 l/min

## Pilot pump:

Type: Gear pump  
Maximum flow: 19 l/min

## Hydraulic motors:

Travel: Variable displacement axial piston motor with mechanical brake  
Slew: Fixed displacement axial piston motor with mechanical brake

## Relief valve setting:

Implement	31,4/34,3 MPa
Travel circuit	34,3 MPa
Slew circuit	26,5 MPa
Pilot circuit	3,9 MPa

## Hydraulic cylinders:

Mono boom	2
Bore x Stroke	ø140 x 1 480 mm
1st boom of 2-piece boom	2
Bore x Stroke	ø140 x 1 480 mm
2nd boom of 2-piece boom	1
Bore x Stroke	ø170 x 1 300 mm
Arm	1
Bore x Stroke	ø150 x 1 745 mm
Bucket	1
Bore x Stroke	ø140 x 1 140 mm
LR bucket	1
Bore x Stroke	ø100 x 865 mm

## Cab

The new-design Volvo Care Cab, with operator protective structure provides security, along with more interior space, leg room and foot space. Audio system with remote control. 3 cup holders, 3 high-capacity outlets. Independently adjustable joystick consoles.

Excellent all around-visibility provided through maximum cab glass, transparent roof hatch and 2-piece sliding door window. The lift-up front windshield can easily be secured at the ceiling and the removable lower front glass can be stored in the side door. Interior lighting consists of one reading light and one cab light with timer.

The pressurized and filtered cab air is supplied by a 14-vent climate-control system, providing fast defrosting and high cooling and heating performance. Viscous/spring-mounted suspension cushions operator from vibrations.

Deluxe seat with adjustable height, tilt, recline, forward-back settings, retractable seat belt and selectable horizontal suspension for reduced whole body vibration.

Adjustable easy-to-read 16,3 cm (6,4") LCD color monitor provides real time information of machine functions, important diagnostic information and a wide variety of work tool settings. LCD monitor is switchable to rear view camera monitor (option).

## Sound Level:

**Sound level in cab according to ISO 6396**  
LpA 71 dB(A)

**External sound level according to ISO 6395 and EU Directive 2000/14/EC**  
LwA 104 dB(A)



## Ground pressure

- **EC290C L** with 6,2 m boom, 3,05 m arm, 1 240 l (975 kg) bucket, 5 800 kg counterweight

Description	Shoe width	Operating weight	Ground pressure	Overall width
Triple grouser	600 mm	29 200 kg	55,1 kPa	3 190 mm
	700 mm	29 700 kg	48,1 kPa	3 290 mm
	800 mm	30 100 kg	42,6 kPa	3 390 mm
	900 mm	30 500 kg	38,4 kPa	3 490 mm
Double grouser	700 mm	29 900 kg	48,4 kPa	3 290 mm

- **EC290C NL** with 6,2 m boom, 2,55 m arm, 1 240 l (975 kg) bucket, 5 800 kg counterweight

Description	Shoe width	Operating weight	Ground pressure	Overall width
Triple grouser	600 mm	29 100 kg	54,9 kPa	2 990 mm
	700 mm	29 600 kg	48,0 kPa	3 090 mm
	800 mm	30 000 kg	42,5 kPa	3 190 mm
	900 mm	30 400 kg	38,2 kPa	3 290 mm

- **EC290C LR** with 10,2 m boom, 7,9 m arm, 520 l (452 kg) bucket, 7 150 kg counterweight

Description	Shoe width	Operating weight	Ground pressure	Overall width
Triple grouser	800 mm	32 100 kg	45,5 kPa	3 390 mm

### Max. permitted buckets

- Note: 1. Bucket size based on ISO 7451, heaped material with a 1:1 angle of repose.  
 2. "Max. permitted sizes" are for reference only and are not necessarily available from the factory.  
 3. Bucket widths are less than bucket's tip radius.

• **EC290C L** with **direct fit bucket**, 5 800 kg counterweight

Description	Max. bucket volume / weight	6,2 m boom		
		2,55 m arm	3,05 m arm	3,7 m arm
GP bucket 1,5 t/m <sup>3</sup>	l / kg	1 950 / 1 650	1 775 / 1 500	1 575 / 1 350
GP bucket 1,8 t/m <sup>3</sup>	l / kg	1 725 / 1 475	1 575 / 1 325	1 400 / 1 200
HD bucket 1,8 t/m <sup>3</sup>	l / kg	1 625 / 1 625	1 500 / 1 500	1 325 / 1 325
HD bucket 2,0 t/m <sup>3</sup>	l / kg	1 525 / 1 525	1 400 / 1 400	1 250 / 1 250

• **EC290C L** with **S quick fit bucket**, 5 800 kg counterweight

Description	Max. bucket volume / weight	6,2 m boom		
		2,55 m arm	3,05 m arm	3,7 m arm
GP bucket 1,5 t/m <sup>3</sup>	l / kg	1 825 / 1 550	1 650 / 1 400	1 475 / 1 250
GP bucket 1,8 t/m <sup>3</sup>	l / kg	1 625 / 1 375	1 475 / 1 250	1 300 / 1 100
HD bucket 1,8 t/m <sup>3</sup>	l / kg	1 525 / 1 525	1 400 / 1 400	1 225 / 1 225
HD bucket 2,0 t/m <sup>3</sup>	l / kg	1 425 / 1 425	1 300 / 1 300	1 150 / 1 150

• **EC290C L** with **U quick fit bucket**, 5 800 kg counterweight

Description	Max. bucket volume / weight	6,2 m boom		
		2,55 m arm	3,05 m arm	3,7 m arm
GP bucket 1,5 t/m <sup>3</sup>	l / kg	1 725 / 1 475	1 575 / 1 325	1 375 / 1 175
GP bucket 1,8 t/m <sup>3</sup>	l / kg	1 550 / 1 300	1 400 / 1 175	1 225 / 1 025
HD bucket 1,8 t/m <sup>3</sup>	l / kg	1 450 / 1 450	1 325 / 1 325	1 150 / 1 150
HD bucket 2,0 t/m <sup>3</sup>	l / kg	1 350 / 1 350	1 225 / 1 225	1 075 / 1 075



• **EC290C NL** with **direct fit bucket**, 5 800 kg counterweight

Description	Max. bucket volume / weight	6,2 m boom		
		2,55 m arm	3,05 m arm	3,7 m arm
GP bucket 1,5 t/m <sup>3</sup>	l / kg	1 725 / 1 475	1 575 / 1 350	1 425 / 1 200
GP bucket 1,8 t/m <sup>3</sup>	l / kg	1 525 / 1 300	1 400 / 1 200	1 250 / 1 050
HD bucket 1,8 t/m <sup>3</sup>	l / kg	1 450 / 1 450	1 325 / 1 325	1 175 / 1 175
HD bucket 2,0 t/m <sup>3</sup>	l / kg	1 350 / 1 350	1 250 / 1 250	1 100 / 1 100

• **EC290C NL** with **S quick fit bucket**, 5 800 kg counterweight

Description	Max. bucket volume / weight	6,2 m boom		
		2,55 m arm	3,05 m arm	3,7 m arm
GP bucket 1,5 t/m <sup>3</sup>	l / kg	1 625 / 1 375	1 475 / 1 250	1 300 / 1 100
GP bucket 1,8 t/m <sup>3</sup>	l / kg	1 425 / 1 225	1 300 / 1 100	1 150 / 975
HD bucket 1,8 t/m <sup>3</sup>	l / kg	1 350 / 1 350	1 225 / 1 225	1 075 / 1 075
HD bucket 2,0 t/m <sup>3</sup>	l / kg	1 250 / 1 250	1 150 / 1 150	1 000 / 1 000

• **EC290C NL** with **U quick fit bucket**, 5 800 kg counterweight

Description	Max. bucket volume / weight	6,2 m boom		
		2,55 m arm	3,05 m arm	3,7 m arm
GP bucket 1,5 t/m <sup>3</sup>	l / kg	1 525 / 1 300	1 375 / 1 175	1 200 / 1 025
GP bucket 1,8 t/m <sup>3</sup>	l / kg	1 350 / 1 150	1 225 / 1 025	1 075 / 900
HD bucket 1,8 t/m <sup>3</sup>	l / kg	1 275 / 1 275	1 150 / 1 150	1 000 / 1 000
HD bucket 2,0 t/m <sup>3</sup>	l / kg	1 200 / 1 200	1 075 / 1 075	950 / 950

## Dimensions

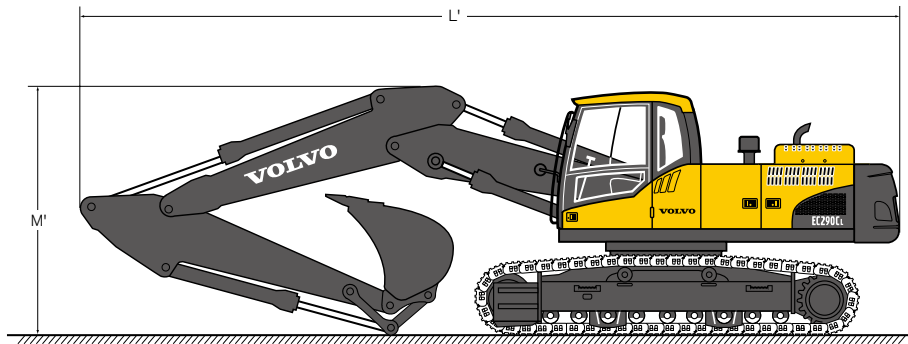
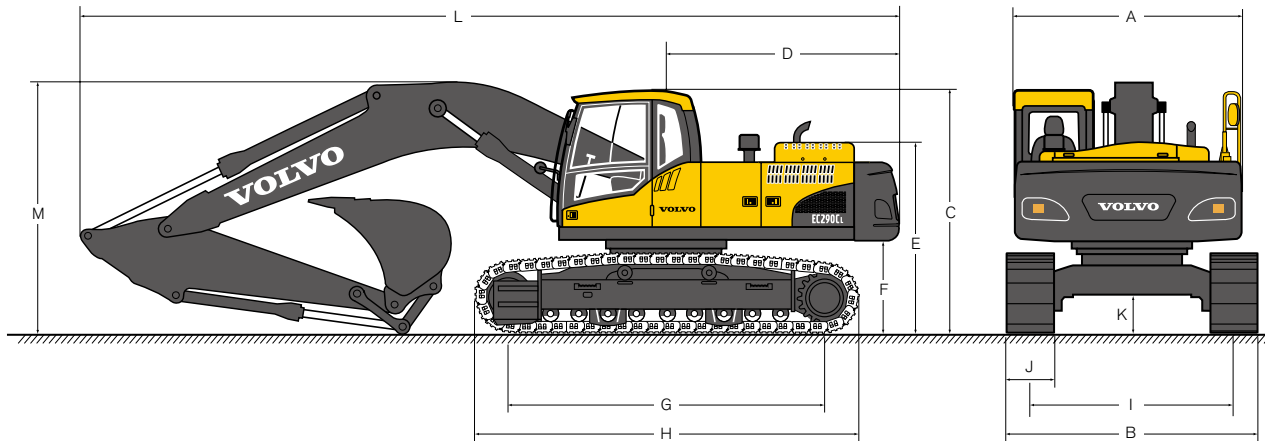

Description		EC290C L		
		6,2 m boom		
		2,55 m arm	3,05 m arm	3,7 m arm
A. Overall width of upper structure	mm	2 890	2 890	2 890
B. Overall width	mm	3 190	3 190	3 190
C. Overall height of cab	mm	3 030	3 030	3 030
D. Tail slew radius	mm	3 000	3 000	3 000
E. Overall height of engine hood	mm	2 400	2 400	2 400
F. Counterweight clearance *	mm	1 145	1 145	1 145
G. Tumbler length	mm	4 015	4 015	4 015
H. Track length	mm	4 870	4 870	4 870
I. Track gauge	mm	2 590	2 590	2 590
J. Shoe width	mm	600	600	600
K. Min. ground clearance *	mm	480	480	480
L. Overall length	mm	10 500	10 420	10 450
L'. Overall length	mm	10 500	10 450	10 440
M. Overall height of boom	mm	3 430	3 290	3 540
M'. Overall height of boom	mm	3 360	3 300	3 550

\* Without shoe grouser



Description		EC290C NL			EC290C LR
		6,2 m boom			10,2 m boom
		2,55 m arm	3,05 m arm	3,7 m arm	7,9 m arm
A. Overall width of upper structure	mm	2 890	2 890	2 890	2 890
B. Overall width	mm	2 990	2 990	2 990	3 390
C. Overall height of cab	mm	3 030	3 030	3 030	3 030
D. Tail slew radius	mm	3 000	3 000	3 000	3 000
E. Overall height of engine hood	mm	2 400	2 400	2 400	2 400
F. Counterweight clearance *	mm	1 145	1 145	1 145	1 145
G. Tumbler length	mm	4 015	4 015	4 015	4 015
H. Track length	mm	4 870	4 870	4 870	4 870
I. Track gauge	mm	2 390	2 390	2 390	2 590
J. Shoe width	mm	600	600	600	800
K. Min. ground clearance *	mm	480	480	480	480
L. Overall length	mm	10 500	10 420	10 450	14 620
L'. Overall length	mm	10 500	10 450	10 440	-
M. Overall height of boom	mm	3 430	3 290	3 540	3 340
M'. Overall height of boom	mm	3 360	3 300	3 550	-

\* Without shoe grouser

• Boom

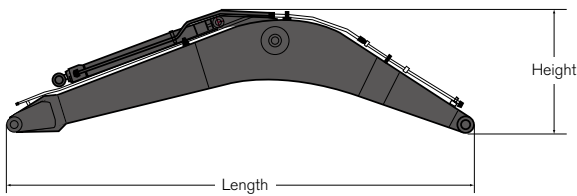

Description		6,2 m	6,2 m HD	6,2 m 2-piece	10,2 m
Length	mm	6 430	6 430	6 430	10 430
Height	mm	1 680	1 680	1 590	1 620
Width	mm	770	770	770	770
Weight	kg	2 480	2 590	3 000	3 420

\* Includes arm cylinder, piping and pin

• Arm

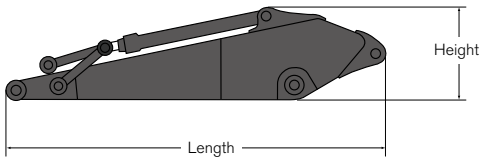

Description		2,55 m	3,05 m	3,05 m HD	3,7 m	7,9 m
Length	mm	3 710	4 150	4 150	4 900	9 060
Height	mm	1 010	1 010	1 010	1 050	1 065
Width	mm	545	545	545	545	545
Weight	kg	1 475	1 480	1 540	1 680	1 790

\* Includes bucket cylinder, linkage and pin

**Working ranges & digging force**

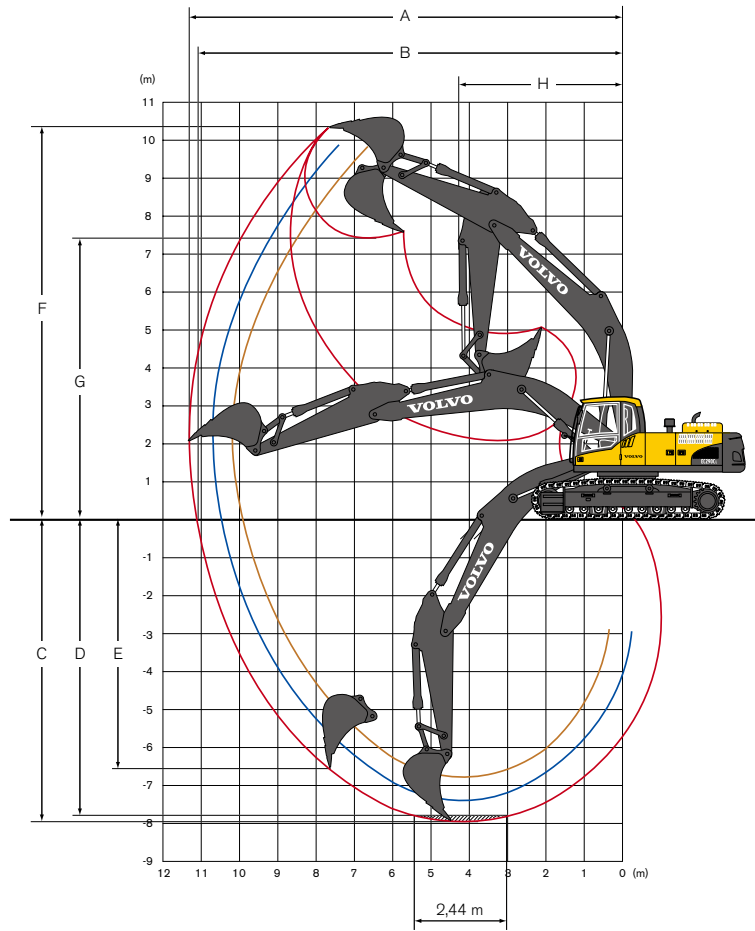

Machine with direct fit bucket		6,2 m boom		
		2,55 m arm	3,05 m arm	3,7 m arm
A. Max. digging reach	mm	10 160	10 690	11 290
B. Max. digging reach on ground	mm	9 950	10 490	11 110
C. Max. digging depth	mm	6 830	7 320	7 980
D. Max. digging depth (2,44 m level)	mm	6 590	7 140	7 820
E. Max. vertical wall digging depth	mm	5 440	6 200	6 590
F. Max. cutting height	mm	9 620	10 040	10 320
G. Max. dumping height	mm	6 690	7 050	7 340
H. Min. front slew radius	mm	4 220	4 180	4 240

Digging forces with direct fit bucket			6,2 m boom		
			2,55 m arm	3,05 m arm	3,7 m arm
Bucket radius		mm	1 600	1 600	1 600
Breakout force - bucket (Normal/Power boost)	SAE J1179	kN	158,0 / 173,0	158,0 / 173,0	158,0 / 173,0
	ISO 6015	kN	181,0 / 198,0	181,0 / 198,0	181,0 / 198,0
Tearout force - arm (Normal/Power boost)	SAE J1179	kN	145,0 / 159,0	123,0 / 135,0	108,0 / 119,0
	ISO 6015	kN	153,0 / 167,0	128,0 / 140,0	111,0 / 122,0
Rotation angle, bucket		deg.	179	179	179

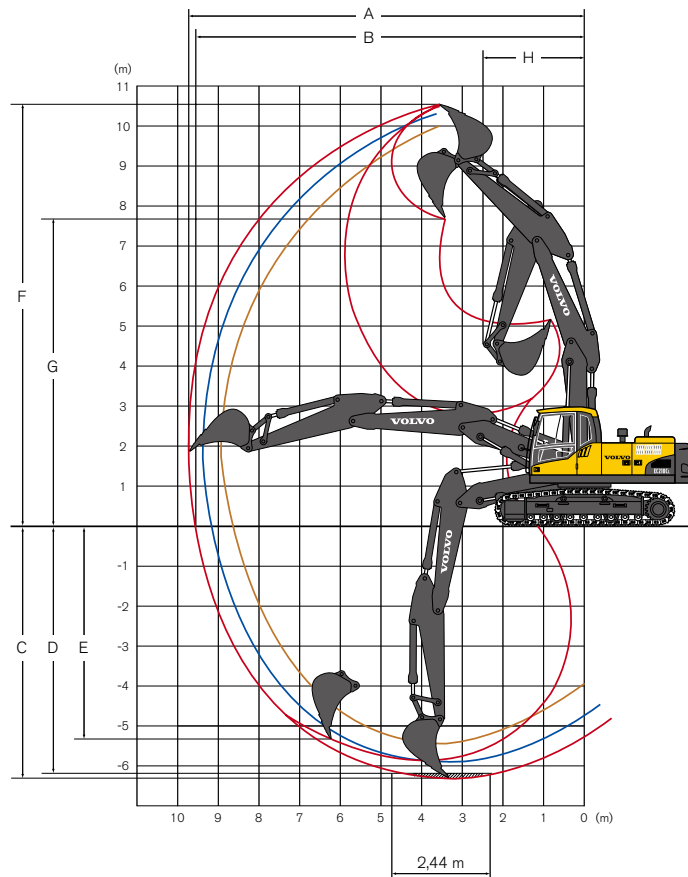

Machine with direct fit bucket		6,2 m 2-piece boom		
		2,55 m arm	3,05 m arm	3,7 m arm
A. Max. digging reach	mm	10 220	10 750	11 370
B. Max. digging reach on ground	mm	10 020	10 560	11 190
C. Max. digging depth	mm	6 200	6 720	7 370
D. Max. digging depth (2,44 m level)	mm	6 100	6 630	7 280
E. Max. vertical wall digging depth	mm	4 530	5 640	6 130
F. Max. cutting height	mm	11 550	12 050	12 550
G. Max. dumping height	mm	8 370	8 860	9 360
H. Min. front slew radius	mm	2 750	2 580	2 760

Digging forces with direct fit bucket			6,2 m 2-piece boom		
			2,55 m arm	3,05 m arm	3,7 m arm
Bucket radius		mm	1 600	1 600	1 600
Breakout force - bucket (Normal/Power boost)	SAE J1179	kN	158,0 / 173,0	158,0 / 173,0	158,0 / 173,0
	ISO 6015	kN	181,0 / 198,0	181,0 / 198,0	181,0 / 198,0
Tearout force - arm (Normal/Power boost)	SAE J1179	kN	145,0 / 159,0	123,0 / 135,0	108,0 / 119,0
	ISO 6015	kN	153,0 / 167,0	128,0 / 140,0	111,0 / 122,0
Rotation angle, bucket		deg.	179	179	179



## Working ranges & digging force

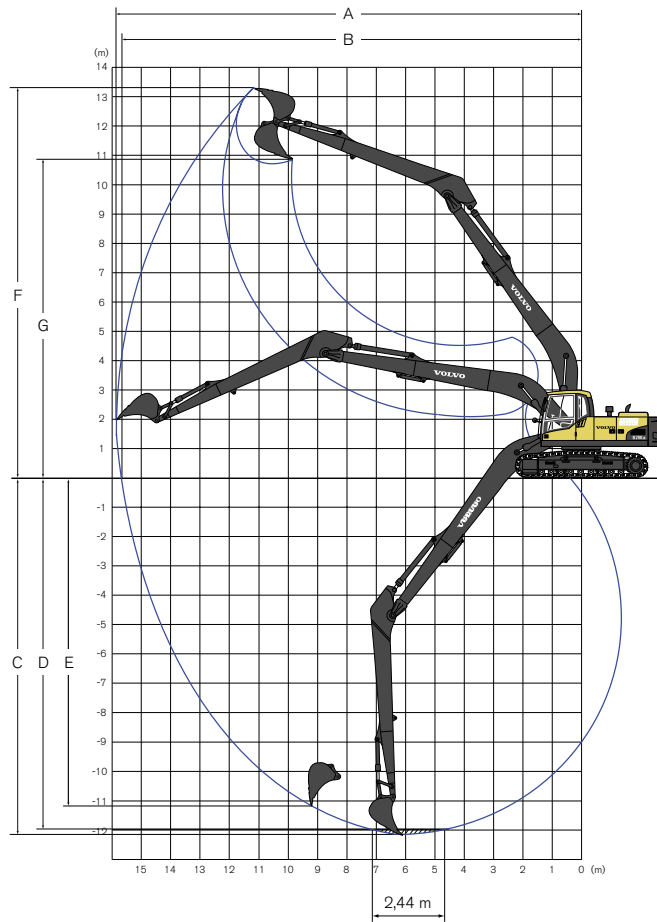

Machine with direct fit bucket		10,2 m boom	
		7,9 m arm	
A. Max. digging reach	mm	18 600	
B. Max. digging reach on ground	mm	18 490	
C. Max. digging depth	mm	14 770	
D. Max. digging depth (2,44 m level)	mm	14 670	
E. Max. vertical wall digging depth	mm	13 520	
F. Max. cutting height	mm	14 920	
G. Max. dumping height	mm	12 580	

















Digging forces with direct fit bucket			10,2 m boom	
			7,9 m arm	
Bucket radius		mm	1 250	
Breakout force - bucket (Normal/Power boost)	SAE J1179	kN	69,1	
	ISO 6015	kN	80,3	
Tearout force - arm (Normal/Power boost)	SAE J1179	kN	64,2	
	ISO 6015	kN	65,1	
Rotation angle, bucket		deg.	179	

## Lifting capacity

At the arm end without bucket.

For lifting capacity including bucket, simply subtract actual weight of the direct fit bucket or the bucket with quick fit from the following values.

### • EC290C L

 Across undercarriage  Along undercarriage	Lifting hook related to ground level	3,0 m		4,5 m		6,0 m		7,5 m		9,0 m		Max. reach				
																Max. mm
Boom 6,2 m + Arm 2,55 m + Shoe 600 mm + Counterweight 5 800 kg	7,5 m kg					*7 310	*7 310							*7 460	6 930	6 511
	6,0 m kg					*7 620	*7 620	*7 440	5 430					*7 450	5 370	7 547
	4,5 m kg			*10 740	*10 740	*8 650	7 520	*7 730	5 330					7 270	4 620	8 178
	3,0 m kg			*13 720	10 760	*10 000	7 120	8 170	5 140					6 730	4 250	8 498
	1,5 m kg			*15 760	10 150	*11 190	6 790	7 980	4 970					6 570	4 120	8 541
	0 m kg			*16 320	9 950	10 980	6 590	7 850	4 850					6 770	4 220	8 313
	-1,5 m kg	*11 570	*11 570	*15 920	9 950	10 920	6 530	7 830	4 830					7 430	4 600	7 788
	-3,0 m kg	*19 830	*19 830	*14 620	10 100	11 020	6 620							8 950	5 500	6 898
-4,5 m kg	*15 820	*15 820	*11 790	10 450									*9 470	7 880	5 462	
Boom 6,2 m + Arm 3,05 m + Shoe 600 mm + Counterweight 5 800 kg	7,5 m kg													*5 780	*5 780	7 195
	6,0 m kg							*6 820	5 530					*5 540	4 790	8 142
	4,5 m kg					*8 050	7 640	*7 270	5 390					*5 530	4 190	8 730
	3,0 m kg			*12 700	11 020	*9 460	7 220	*7 980	5 190	*5 970	3 900			*5 700	3 880	9 030
	1,5 m kg			*15 110	10 300	*10 790	6 850	8 010	4 990	6 080	3 810			6 010	3 770	9 070
	0 m kg			*16 180	9 970	11 000	6 600	7 840	4 840					6 160	3 840	8 856
	-1,5 m kg	*10 580	*10 580	*16 150	9 900	10 890	6 500	7 780	4 780					6 660	4 140	8 366
	-3,0 m kg	*17 570	*17 570	*15 210	9 990	10 930	6 540	7 850	4 850					7 790	4 810	7 546
-4,5 m kg	*17 890	*17 890	*13 000	10 260	*9 500	6 760							*8 870	6 390	6 264	
Boom 6,2 m + Arm 3,7 m + Shoe 600 mm + Counterweight 5 800 kg	7,5 m kg							*5 820	5 670					*4 550	*4 550	7 949
	6,0 m kg							*6 060	5 620					*4 370	4 220	8 815
	4,5 m kg					*7 170	*7 170	*6 610	5 450	*5 850	4 010			*4 360	3 740	9 360
	3,0 m kg			*11 250	*11 250	*8 650	7 320	*7 400	5 220	6 190	3 910			*4 490	3 480	9 639
	1,5 m kg			*14 030	10 450	*10 130	6 890	8 010	4 980	6 060	3 790			*4 750	3 380	9 678
	0 m kg	*6 130	*6 130	*15 660	9 960	10 990	6 580	7 810	4 800	5 960	3 690			*5 220	3 420	9 477
	-1,5 m kg	*9 950	*9 950	*16 140	9 780	10 800	6 420	7 690	4 690	5 920	3 660			5 900	3 640	9 021
	-3,0 m kg	*15 060	*15 060	*15 660	9 800	10 780	6 390	7 690	4 690					6 710	4 130	8 268
-4,5 m kg	*20 020	*20 020	*14 090	9 990	*10 490	6 520							*8 280	5 190	7 121	
-6,0 m kg	*14 790	*14 790	*10 500	10 430									*8 450	8 160	5 323	
2-piece boom 6,2 m + Arm 2,55 m + Shoe 600 mm + Counterweight 5 800 kg	9,0 m kg			*10 940	*10 940									*9 690	*9 690	4 920
	7,5 m kg			*10 690	*10 690	*9 500	7 980							*8 470	6 740	6 590
	6,0 m kg	*10 960	*10 960	*11 610	*11 610	*9 730	7 840	8 520	5 390					*8 070	5 230	7 620
	4,5 m kg			*13 490	11 670	*10 480	7 480	8 390	5 270					7 160	4 490	8 240
	3,0 m kg			*15 480	10 640	*11 340	7 050	8 170	5 070					6 630	4 130	8 560
	1,5 m kg					11 190	6 680	7 960	4 890					6 480	4 000	8 600
	0 m kg			*15 320	9 780	10 950	6 480	7 820	4 770					6 670	4 100	8 380
	-1,5 m kg			*13 520	9 810	*10 620	6 430	7 810	4 750					7 320	4 480	7 860
-3,0 m kg			*10 670	9 990	*8 430	6 540	-						*6 520	5 370	6 970	
2-piece boom 6,2 m + Arm 3,05 m + Shoe 600 mm + Counterweight 5 800 kg	9,0 m kg			*8 780	*8 780									*6 620	*6 620	5 810
	7,5 m kg			*8 250	*8 250	*8 440	8 150							*5 860	5 790	7 270
	6,0 m kg			*8 740	*8 740	*9 180	7 980	*8 180	5 500					*5 560	4 660	8 210
	4,5 m kg			*12 670	11 980	*10 030	7 610	8 470	5 350					*5 510	4 070	8 800
	3,0 m kg			*14 850	10 930	*11 000	7 160	8 230	5 130	6 160	3 840			*5 640	3 770	9 090
	1,5 m kg			*16 060	10 150	11 270	6 750	7 990	4 910	6 060	3 750			5 920	3 660	9 130
	0 m kg			*15 790	9 800	10 970	6 490	7 820	4 760					6 080	3 730	8 920
	-1,5 m kg	*9 820	*9 820	*14 370	9 740	10 860	6 390	7 760	4 700					6 580	4 030	8 430
-3,0 m kg			*11 900	9 870	*9 290	6 450	*6 610	4 790					*6 290	4 690	7 620	
2-piece boom 6,2 m + Arm 3,7 m + Shoe 600 mm + Counterweight 5 800 kg	9,0 m kg					*6 630	*6 630							*5 120	*5 120	6 740
	7,5 m kg					*6 850	*6 850	*6 120	5 670					*4 620	*4 620	8 040
	6,0 m kg			*6 460	*6 460	*7 150	*7 150	*7 060	5 620					*4 420	4 110	8 890
	4,5 m kg	*8 950	*8 950	*8 930	*8 930	*8 710	7 780	*8 080	5 430	*6 160	3 980			*4 370	3 630	9 430
	3,0 m kg			*13 820	11 280	*10 430	7 280	8 300	5 180	6 190	3 860			*4 460	3 380	9 710
	1,5 m kg			*15 560	10 320	*11 330	6 810	8 010	4 920	6 050	3 730			*4 700	3 280	9 750
	0 m kg	*5 450	*5 450	*15 940	9 780	10 960	6 470	7 790	4 720	5 940	3 630			*5 110	3 330	9 550
	-1,5 m kg	*9 310	*9 310	*15 080	9 600	10 770	6 300	7 670	4 620	5 910	3 600			*5 780	3 550	9 100
-3,0 m kg	*14 470	*14 470	*13 120	9 640	*10 070	6 290	*7 630	4 620					*6 080	4 030	8 350	
-4,5 m kg			*9 830	*9 830	*7 500	6 450							*6 100	5 440	6 800	

















- Notes:
1. Machine in "Fine Mode-F" (Power Boost) for lifting capacities.
  2. The above loads are in compliance with SAE J1097 and ISO 10567 Hydraulic Excavator Lifting Capacity Standards.
  3. Rated loads do not exceed 87% of hydraulic lifting capacity or 75% of tipping load.
  4. Rated loads marked with an asterisk (\*) are limited by hydraulic capacity rather than tipping load.

## Lifting capacity

At the arm end without bucket.

For lifting capacity including bucket, simply subtract actual weight of the direct fit bucket or the bucket with quick fit from the following values.

### • EC290C NL

 Across undercarriage  Along undercarriage	Lifting hook related to ground level	3,0 m		4,5 m		6,0 m		7,5 m		9,0 m		Max. reach				
																Max. mm
Boom 6,2 m + Arm 2,55 m + Shoe 600 mm + Counterweight 5 800 kg	7,5 m kg					*7 310	*7 310							*7 460	6 380	6 510
	6,0 m kg					*7 620	7 220	*7 440	5 000					*7 450	4 940	7 540
	4,5 m kg			*10 740	10 650	*8 650	6 900	*7 730	4 890					7 240	4 240	8 170
	3,0 m kg			*13 720	9 740	*10 000	6 510	8 150	4 710					6 700	3 890	8 490
	1,5 m kg			*15 760	9 150	11 170	6 180	7 950	4 540					6 550	3 760	8 540
	0 m kg			*16 320	8 960	10 940	5 990	7 820	4 420					6 740	3 850	8 310
	-1,5 m kg	*11 570	*11 570	*15 920	8 960	10 880	5 930	7 800	4 400					7 400	4 200	7 780
	-3,0 m kg	*19 830	18 000	*14 620	9 110	10 980	6 020							8 920	5 020	6 890
-4,5 m kg	*15 820	*15 820	*11 790	9 450									*9 470	7 170	5 460	
Boom 6,2 m + Arm 3,05 m + Shoe 600 mm + Counterweight 5 800 kg	7,5 m kg													*5 780	5 480	7 190
	6,0 m kg							*6 820	5 090					*5 540	4 400	8 140
	4,5 m kg					*8 050	7 010	*7 270	4 950					*5 530	3 840	8 730
	3,0 m kg			*12 700	10 000	*9 460	6 610	*7 980	4 750	*5 970	3 570			*5 700	3 550	9 030
	1,5 m kg			*15 110	9 300	*10 790	6 240	7 980	4 560	6 060	3 480			5 990	3 440	9 070
	0 m kg			*16 180	8 980	10 960	6 000	7 820	4 410					6 140	3 500	8 850
	-1,5 m kg	*10 580	*10 580	*16 150	8 910	10 850	5 900	7 750	4 350					6 640	3 770	8 360
	-3,0 m kg	*17 570	*17 570	*15 210	9 000	10 890	5 940	7 820	4 420					7 760	4 390	7 540
-4,5 m kg	*17 890	*17 890	*13 000	9 260	*9 500	6 150							*8 870	5 820	6 260	
Boom 6,2 m + Arm 3,7 m + Shoe 600 mm + Counterweight 5 800 kg	7,5 m kg							*5 820	5 230					*4 550	*4 550	7 940
	6,0 m kg							*6 060	5 180					*4 370	3 870	8 810
	4,5 m kg					*7 170	7 140	*6 610	5 010	*5 850	3 680			*4 360	3 420	9 360
	3,0 m kg			*11 250	10 290	*8 650	6 700	*7 400	4 780	6 160	3 570			*4 490	3 170	9 630
	1,5 m kg			*14 030	9 450	*10 130	6 280	7 970	4 550	6 030	3 450			*4 750	3 080	9 670
	0 m kg	*6 130	*6 130	*15 660	8 970	10 930	5 980	7 760	4 370	5 920	3 360			*5 220	3 110	9 470
	-1,5 m kg	*9 950	*9 950	*16 140	8 790	10 740	5 820	7 650	4 270	5 880	3 320			5 870	3 310	9 020
	-3,0 m kg	*15 060	*15 060	*15 660	8 810	10 720	5 790	7 650	4 270					6 670	3 760	8 260
-4,5 m kg	*20 020	17 730	*14 090	8 990	*10 490	5 920							*8 280	4 720	7 120	
-6,0 m kg	*14 790	*14 790	*10 500	9 430									*8 450	7 410	5 320	
2-piece boom 6,2 m + Arm 2,55 m + Shoe 600 mm + Counterweight 5 800 kg	9,0 m kg			*10 940	*10 940									*9 690	*9 690	4 920
	7,5 m kg			*10 690	*10 690	*9 500	7 340							*8 470	6 200	6 590
	6,0 m kg	*10 960	*10 960	*11 610	11 460	*9 730	7 200	8 490	4 940					*8 070	4 800	7 620
	4,5 m kg			*13 490	10 610	*10 480	6 850	8 360	4 830					7 140	4 110	8 240
	3,0 m kg			*15 480	9 610	*11 340	6 420	8 140	4 630					6 600	3 760	8 560
	1,5 m kg					11 150	6 070	7 930	4 450					6 450	3 640	8 600
	0 m kg			*15 320	8 780	10 910	5 860	7 800	4 330					6 650	3 730	8 380
	-1,5 m kg			*13 520	8 810	*10 620	5 820	7 780	4 320					7 300	4 070	7 860
-3,0 m kg			*10 670	8 990	*8 430	5 930							*6 520	4 880	6 970	
2-piece boom 6,2 m + Arm 3,05 m + Shoe 600 mm + Counterweight 5 800 kg	9,0 m kg			*8 780	*8 780	*8 440	7 510							*6 620	*6 620	5 810
	7,5 m kg			*8 250	*8 250	*8 440	7 510							*5 860	5 320	7 270
	6,0 m kg			*8 740	*8 740	*9 180	7 340	*8 180	5 050					*5 560	4 270	8 210
	4,5 m kg			*12 670	10 910	*10 030	6 980	8 450	4 900					*5 510	3 720	8 800
	3,0 m kg			*14 850	9 900	*11 000	6 530	8 200	4 680	6 140	3 500			*5 640	3 430	9 090
	1,5 m kg			*16 060	9 130	11 230	6 130	7 960	4 470	6 040	3 410			5 900	3 330	9 130
	0 m kg			*15 790	8 800	10 930	5 880	7 790	4 320					6 050	3 390	8 920
	-1,5 m kg	*9 820	*9 820	*14 370	8 740	10 820	5 780	7 730	4 260					6 550	3 660	8 430
-3,0 m kg			*11 900	8 860	*9 290	5 830	*6 610	4 350					*6 290	4 270	7 620	
2-piece boom 6,2 m + Arm 3,7 m + Shoe 600 mm + Counterweight 5 800 kg	9,0 m kg					*6 630	*6 630							*5 120	*5 120	6 740
	7,5 m kg					*6 850	*6 850	*6 120	5 220					*4 620	4 550	8 040
	6,0 m kg			*6 460	*6 460	*7 150	*7 150	*7 060	5 160					*4 420	3 760	8 890
	4,5 m kg	*8 950	*8 950	*8 930	*8 930	*8 710	7 140	*8 080	4 980	*6 160	3 630			*4 370	3 310	9 430
	3,0 m kg			*13 820	10 220	*10 430	6 650	8 270	4 730	6 170	3 520			*4 460	3 070	9 710
	1,5 m kg			*15 560	9 290	11 320	6 190	7 980	4 480	6 030	3 390			*4 700	2 980	9 750
	0 m kg	*5 450	*5 450	*15 940	8 780	10 930	5 860	7 760	4 280	5 920	3 290			*5 110	3 020	9 550
	-1,5 m kg	*9 310	*9 310	*15 080	8 600	10 730	5 690	7 640	4 180	5 890	3 260			*5 780	3 220	9 100
-3,0 m kg	*14 470	*14 470	*13 120	8 640	*10 070	5 680	*7 630	4 190					*6 080	3 660	8 350	
-4,5 m kg			*9 830	8 870	*7 500	5 840							*6 100	4 930	6 800	

- Notes:
1. Machine in "Fine Mode-F" (Power Boost) for lifting capacities.
  2. The above loads are in compliance with SAE J1097 and ISO 10567 Hydraulic Excavator Lifting Capacity Standards.
  3. Rated loads do not exceed 87% of hydraulic lifting capacity or 75% of tipping load.
  4. Rated loads marked with an asterisk (\*) are limited by hydraulic capacity rather than tipping load.





















## Lifting capacity

At the arm end without bucket.

For lifting capacity including bucket, simply subtract actual weight of the direct fit bucket or the bucket with quick fit from the following values.

### • EC290C LR

 Across undercarriage  Along undercarriage	Lifting hook related to ground level	6,0 m		7,5 m		9,0 m		10,5 m		12,0 m		13,5 m		15,0 m		Max. reach			
																		Max. mm	
Boom 10,2 m + Arm 7,9 m + Shoe 800 mm + Counterweight 7 150 kg	13,5 m	kg															*1 150	*1 150	12 910
	12,0 m	kg										*1 630	*1 630				*1 080	*1 080	14 120
	10,5 m	kg										*2 170	*2 170	*1 130	*1 130	*1 040	*1 040	*1 040	15 080
	9,0 m	kg										*2 510	*2 510	*1 800	*1 800	*1 020	*1 020	*1 020	15 840
	7,5 m	kg										*2 720	2 640	*2 220	2 080	*1 010	*1 010	*1 010	16 420
	6,0 m	kg									*2 990	*2 990	*2 850	2 530	*2 560	2 010	*1 020	*1 020	16 850
	4,5 m	kg							*3 490	*3 490	*3 220	3 010	*3 010	2 400	*2 860	1 920	*1 040	*1 040	17 140
	3,0 m	kg			*5 170	*5 170	*4 380	*4 380	*3 850	3 520	*3 470	2 810	*3 190	2 250	*2 980	1 820	*1 080	*1 080	17 300
	1,5 m	kg	*7 700	7 140	*5 950	5 290	*4 900	4 090	*4 210	3 240	*3 730	2 600	*3 380	2 110	2 960	1 710	*1 130	*1 130	17 320
	0 m	kg	*8 660	6 290	*6 600	4 740	*5 360	3 710	*4 540	2 970	*3 970	2 410	3 390	1 970	2 850	1 610	*1 200	1 190	17 210
	-1,5 m	kg	*9 260	5 730	*7 090	4 320	*5 730	3 400	4 720	2 740	3 890	2 240	3 260	1 840	2 760	1 520	*1 290	1 180	16 960
	-3,0 m	kg	*8 940	5 390	7 230	4 030	5 610	3 170	4 520	2 560	3 740	2 100	3 150	1 740	2 680	1 450	*1 410	1 200	16 580
	-4,5 m	kg	*9 440	5 220	7 040	3 850	5 440	3 010	4 390	2 430	3 640	2 000	3 070	1 670	2 630	1 400	*1 580	1 250	16 040
	-6,0 m	kg	*9 470	5 160	6 940	3 770	5 340	2 930	4 310	2 360	3 570	1 940	3 030	1 630	2 620	1 390	*1 810	1 340	15 340
	-7,5 m	kg	*9 090	5 200	6 930	3 760	5 320	2 900	4 280	2 330	3 560	1 930	3 030	1 630			*2 140	1 490	14 450
	-9,0 m	kg	*8 470	5 310	*6 830	3 820	5 360	2 940	4 320	2 370	3 600	1 970					*2 660	1 720	13 330
	-10,5 m	kg	*7 540	5 510	*6 130	3 960	*5 070	3 050	*4 200	2 470							*3 420	2 100	11 910
-12,0 m	kg	*6 170	5 820	*5 030	4 200	*4 080	3 260									*3 410	2 820	10 080	
-13,5 m	kg			*3 140	*3 140											*3 130	*3 130	7 520	

- Notes:
1. Machine in "Fine Mode-F" (Power Boost) for lifting capacities.
  2. The above loads are in compliance with SAE J1097 and ISO 10567 Hydraulic Excavator Lifting Capacity Standards.
  3. Rated loads do not exceed 87% of hydraulic lifting capacity or 75% of tipping load.
  4. Rated loads marked with an asterisk (\*) are limited by hydraulic capacity rather than tipping load.

## STANDARD EQUIPMENT

### Engine

Turbocharged, 4 stroke diesel engine with water cooling, direct injection and charged air cooler that meets EU Stage IIIA requirements  
3-stage air filter with indicator and precleaner  
Air intake heater  
Electric engine shut-off  
Fuel filter and water separator  
Fuel filler pump: 50 l/min, with automatic shut-off  
Alternator, 80 A

### Electric/Electronic control system

Contronics  
– Advanced mode control system  
– Self-diagnostic system  
Machine status indication  
Engine speed sensing power control  
Automatic idling system  
One-touch power boost  
Safety stop/start function  
Adjustable LCD color monitor  
Master electrical disconnect switch  
Engine restart prevention circuit  
High-capacity halogen lights:  
– Frame-mounted 2  
– Boom-mounted 2  
Batteries, 2 x 12 V / 200 Ah  
Start motor, 24 V / 5,5 kW

### Hydraulic system

Hose rupture valve: boom  
Overload warning device

Automatic sensing hydraulic system

- Summation system
- Boom priority
- Arm priority
- Slew priority

Boom and arm regeneration valves  
Slew anti-rebound valves  
Boom and arm holding valves  
Multi-stage filtering system  
Cylinder cushioning  
Cylinder contamination seals  
Auxiliary hydraulic valve  
Automatic two-speed travel motors  
Hydraulic oil, ISO VG 46

### Superstructure

Access way with handrail  
Full height counterweight:  
– L: 5 800 kg  
– NL: 5 800 kg  
– LR: 7 150 kg  
Tool storage area  
Punched metal anti-slip plates  
Undercover (heavy-duty 4,5 mm)

### Cab and interior

Fabric seat with heater and air suspension  
Control joysticks with 4 switches each  
Heater & air-conditioner, automatic  
Hydraulic dampening cab mounts  
Adjustable operator seat and joystick control console  
Flexible antenna  
Hydraulic safety lock lever

Cab, all-weather sound suppressed, includes:

- Ashtray
  - Cup holder (x3)
  - Lighter
  - Door locks
  - Tinted glass
  - Floor mat
  - Horn
  - Large storage area
  - Pull-up type front window
  - Removable lower windshield
  - Seat belt
  - Safety glass
  - Sun shields, front, roof, rear
  - Rain shield
  - Windshield wiper with intermittent feature
- Anti-vandalism kit assembly preparation  
Master key

### Undercarriage

Hydraulic track adjusters  
Greased and sealed track link  
Track guide  
Undercover (heavy-duty 10 mm)

### Track shoes

Track shoes 600 mm with triple grousers

### Digging equipment

Boom: 6,2 m monoblock  
Arm: 3,05 m  
Centralized lubrication

### Service

Tool kit, daily maintenance

## OPTIONAL EQUIPMENT

### Engine

Block heater: 120 V, 240 V  
Oil bath pre-cleaner  
Diesel driven coolant heater  
Water separator with heater

### Electric

Extra lights:  
– Cab-mounted 3  
– Counterweight-mounted 1  
Travel alarm  
Anti-theft system  
Rotating warning beacon

### Hydraulic system

Hose rupture valve: arm  
Boom float function  
Hydraulic piping:  
– Hammer & shear, 1 and 2 pump flow  
– Additional return filter

- Slope & rotator
- Grapple
- Oil leak (drain) line
- Quick fit piping

Volvo hydraulic quick fit, S2 size  
Hydraulic oil, ISO VG 32  
Hydraulic oil, ISO VG 68  
Hydraulic oil, biodegradable 32  
Hydraulic oil, biodegradable 46

### Cab and interior

Fabric seat  
Fabric seat with heater  
Control joystick with semi-long levers  
Control joystick with proportional control  
Falling object guard (FOG)  
– Frame-mounted  
– Cab-mounted  
Cab-mounted falling object protective structure (FOPS)

Screen guard for front window  
Sunlight protection, roof (steel)  
Lower wiper with intermittent control  
Anti-vandalism kit  
Specific key  
Rear view camera

### Undercarriage

Full track guard

### Digging equipment

Boom: 6,2 m 2-piece  
10,2 m long reach  
Arm: 2,55 m  
3,7 m  
7,9 m long reach

### Service

Tool kit, full scale

## NOTES





Volvo Construction Equipment is different. It's designed, built and supported in a different way. That difference comes from an engineering heritage of over 170 years. A heritage of thinking first about the people who actually use the machines. About how to help them be safer, more comfortable, more productive. About the environment we all share. The result of that thinking is a growing range of machines and a global support network dedicated to helping you do more. People around the world are proud to use Volvo. And we're proud of what makes Volvo different – **More care. Built in.**

# ARAG

ARAG Bau AG

Zinggen

6166 Hasle LU

[www.arag-bau.ch](http://www.arag-bau.ch)

Tel. 058 710 00 00

## Baumaschinen-Rent

*Not all products are available in all markets. Under our policy of continuous improvement, we reserve the right to change specifications and design without prior notice. The illustrations do not necessarily show the standard version of the machine.*

# VOLVO

Construction Equipment  
[www.volvo.com](http://www.volvo.com)

Ref. No. 21 B 100 3310 English (Global)  
Printed in Sweden 2007.07-1,0 EXC  
Volvo, Seoul