

NEW

JS200/210/220 | **HYDRAULIC EXCAVATOR**

English



printed from www.arag-bau.ch

Hydraulic Excavator JS200/210/220/NLC/SC/LC

Engine Power: 129kW (173hp) | Bucket Capacity: 0.4 – 1.19m³ | Operating Weight: 19618 – 22490kg

ARAG
Baumaschinen-Rent

ARAG Bau AG
Zingen

6166 Hasle LU
www.arag-bau.ch
Tel. 058 710 00 00

STRENGTH INSIDE AND OUT

BEFORE YOU BUY AN EXCAVATOR, YOU NEED TO KNOW IT'S GOING TO BE TOUGH ENOUGH TO PERFORM ANY JOB YOU ASK OF IT. FORTUNATELY, WITH A JCB JS200/210/220, STRENGTH AND DURABILITY COME AS STANDARD.



1

Boom and dipper

- 1 A new reinforced boom and dipper is made of high tensile strength steel, with three piece wrapper plates and cast ends for strength and durability.
- 2 Our advanced manufacturing and assembly processes produce high precision and quality assembled components.

Componentry

- 3 Our engine technology is tried and proven; we've built 200,000 DIESELMAX units since 2004. To ensure similar longevity, the JS200/210/220's EcoMAX T4i/Stage IIIB engine has been tested for 110,000 hours in 70 different machines across the toughest applications and environments.
- 4 JCB JS200/210/220s boast the best components in the industry, including Berco running gear, Kawasaki pumps, Kayaba valve blocks and JCB EcoMAX engines.

We use Finite Element Analysis with extensive rig and endurance testing to make key components last longer.



2



3



4



Structural strength

- 5 The high-strength undercarriage of a JCB JS200/210/220 uses a fully-welded X frame construction for long-term durability even in the most demanding applications.
- 6 A closed box section revolving frame increases strength and reduces stress. It's also highly resistant to impact damage.
- 7 The high-strength rigid upper frame provides maximum durability and support.
- 8 Our stiff, durable door design gives great strength and rigidity.

UNEARTHED: KEY FACT

The JCB JS200/210/220 turret is welded to both the upper and lower undercarriage frame.



5

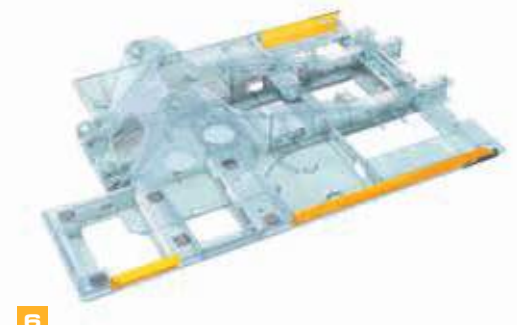

6



8



7

MAXIMUM PRODUCTIVITY, MINIMUM SPEND

SAVING MONEY AND TIME IS MORE IMPORTANT THAN EVER, SO WE'VE MADE SURE THE NEW JCB JS200/210/220'S COMPONENTRY – INCLUDING THE ECOMAX T4i ENGINE – WORKS IN PERFECT HARMONY. IN TURN, YOU GET A MACHINE THAT'S AS EFFICIENT AND PRODUCTIVE AS POSSIBLE.

The JS200/210/220 is a hugely versatile machine that's made all the more so by a big range of attachments, enabling you to carry out a wide range of tasks.

Versed in versatility

1 JCB's quickhitch system makes attachment changing fast and easy, and is purpose-designed for the JS range.

For ultra versatility, JCB offers a full list of auxiliary pipework options including hammer, auxiliary, and low flow.

Choose the optional rubber street pads and you can use the JS200/210/220 on sensitive grounds like tarmac without causing damage.



Upping output

- 2 Simultaneous tracking and excavating is smooth and fast with an intuitive multifunction operation.
- 3 A JCB JS200/210/220 has a solid, stable work platform for fast cycle times.
- 4 With a massive 15200 Kgf bucket tearout and fast cycle times, the JS200/210/220 is extremely productive in all applications.
- 5 JCB's innovative hydraulic regeneration system means oil is recycled across the cylinders for faster cycle times and reduced fuel consumption.

The efficient excavator

- 6 JCB's new EcoMAX T4i/Stage3B engine uses up to 10% less fuel than our Tier 3 units, saving you money. This is partly due to the fact that EcoMAX produces high torque at just 1500 -1600 rpm, making for improved fuel-efficient matching of the hydraulics.
- 7 To reduce noise pollution from unnecessary air flow, the engine-driven cooling fan has a proportional control system, maintaining optimum fan speed.
- 8 The JS200/210/220 variable power bands allow you to tailor performance – and therefore economy – to specific tasks.



To save fuel, JCB Auto-Idle technology automatically reduces engine speed when hydraulics aren't in use. To optimise fuel efficiency still further, the JS200/210/220 benefits from advanced hydraulic technology, including optimised hydraulic pump settings, advanced spool design, and cutting edge electronic management software.

UNEARTHED: KEY FACT
A JCB JS200/210/220 has cushioned boom and dipper ends to prevent shock loadings, protect your machine and increase operator comfort.



A COMFORTABLE FAVOURITE

JCB EXCAVATORS ARE DESIGNED AROUND THE OPERATOR. THAT'S GOOD FOR THEM BUT EVEN BETTER FOR YOU; AFTER ALL, GREAT COMFORT AND EASE OF USE EQUALS GREAT PRODUCTIVITY.

Excellent visibility

1 A 70/30 front screen split gives JCB JS200/210/220 excellent front visibility. A clear view of the front right track provides easy, safe trench digging and manoeuvring.

2 An innovative low-level bonnet provides excellent rearward visibility.

Comfortably in control

3 The 7" colour monitor multi-function display is easy to read in all light conditions, provides instant operational information, and has a customisable home screen.

The JS200/210/220 Tool Select feature can set up auxiliary hydraulic circuits quickly and accurately to match flow and pressure requirements of any attachment.

Light, intuitive and smooth controls improve comfort and productivity. The JS200/210/220 joystick-mounted power boost button gives extra hydraulic power fast.

A large laminated glass roof window gives the JS200/210/220 optimum visibility for working at height.

A balanced slew and electronic/hydraulic controlled slew braking give speed and precision.



The JS200/210/220 cab and controls are independently adjustable so that it's easy to find the perfect operating position.

The working environment

4 The JS200/210/220 creates a quieter working environment inside and out. Because we've reduced noise levels to 72dB(A) inside and 103dB(A) outside, you can use the machine at any location, anytime.

JCB JS200/210/220 cabs use 6 viscous rubber mounts to minimise noise and vibration.

The positive pressure cab keeps out dirt and dust.

5 JCB's climate control option offers a precisely controlled cab temperature with fresh or recirculated air. Demisting/defrosting functions keep the front window clear.

6 There's a spacious luggage tray behind the operator's seat.

7 A large floor area with large high grip pedals gives easy and precise tracking.



5



6



7



4

We offer tailored seating options to suit many different applications.

LESS SERVICING, MORE SERVICE

WE'VE DESIGNED THE JCB JS200/210/220 TO BE LOW MAINTENANCE AND EASILY SERVICEABLE. THIS MAKES IT AFFORDABLE, EFFICIENT AND HIGHLY PRODUCTIVE, HELPING YOU GET THE BEST SERVICE FROM YOUR MACHINE.



By using graphite impregnated bronze bushes, we've reduced the JS200/210/220 boom and dipper greasing intervals to 1000 hours for normal applications.

UNEARTHED: KEY FACT
JCB JS200/210/220 grease points are centralised for safe and easy access to high level pivots.



1

Easy does it

- 1 The air filter on a JS200/210/220 is easily accessible, and a double-element construction simplifies cleaning.
- 2 The filters on a JS200/210/220 (engine oil, hydraulic oil and fuel) are centrally located for fast, easy servicing.
- 3 Because they're mounted side by side, the engine radiator, hydraulic cooler and intercooler can be serviced individually yet cleaned easily.

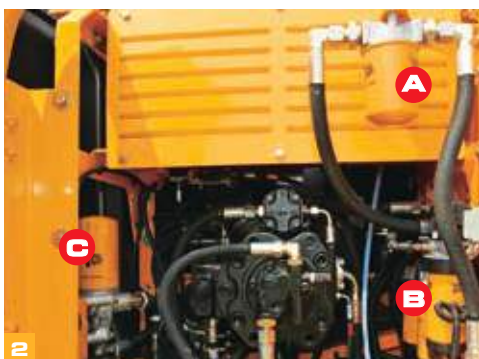

(A) Hydraulics oil filters (B) Fuel filters (C) Engine Oil Filter

	SERVICE INTERVALS
Engine oil and oil filter	Every 500 hours
Hydraulic oil filter	Every 1 000 hours
Hydraulic oil	Every 5000 hours



3

JCB JS200/210/220 bonnets open and close easily with gas-assisted cylinders, and the service bays are large and wide for good access.

Here to help

4 Because the EcoMAX engine doesn't need exhaust after treatment, it doesn't require costly heat-resistant lube oils.

Unlike most Tier 4i engines, JCB EcoMAX doesn't use a Diesel Particulate Filter (DPF) or SCR, saving you additional running costs.

5 We've eliminated the need for a visibowl style pre-cleaner on the JS200/210/220 with our new scavenger filtration system. This uses suction from the cooling fan to remove heavier particles from the induction system.

6 Our innovative recalibration option allows EcoMAX to run on lower grade fuels. This means the JS200/210/220 can be resold across different territories, which improves residuals.

7 JCB's In-Cab Monitor checks engine oil levels, coolant, and system errors on start-up.



4



5



6



7

THE SAFE CHOICE

ON-SITE SAFETY IS CRUCIAL, SO WE'VE DESIGNED THE JCB JS200/210/220 TO INCORPORATE AS MANY CUTTING EDGE SAFEGUARDS AS POSSIBLE. IN SHORT, YOUR OPERATORS ARE IN SAFE HANDS.



1 The JS200/210/220 bonnet opens front-to-rear for easy and safe engine service access.

2 For extra peace of mind, JCB JS200/210/220 cabs are available with an integral Rollover Protection Structure (ROPS). It's also easy to fit JCB's Falling Objects Protection Structure (FOPS), thanks to standard fitment mounting brackets.

3 JCB's Safety Level Lock fully isolates hydraulic functions to avoid unintended movements. Our 2GO system means a JCB JS200/210/220 can only be started in a safe locked position via two separate inputs.

4 JCB JS200/210/220s have a large glass area and low bonnet line for superb visibility.

5 A JCB JS200/210/220's steps and platforms have anti-slip punched steel plates for optimum grip, even in wet or icy conditions. Bolt-on plates have recessed bolts to reduce trip hazards.

6 Our standard rear and optional side view cameras display uninterrupted rearwards and sideways views on the smart controller display.

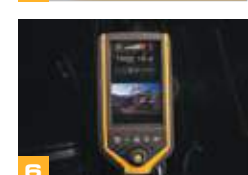
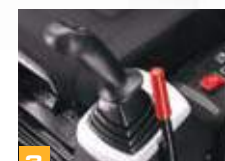

7 Your JS200/210/220 is equipped with a full set of side and rear view mirrors for all round visibility and safety compliance.

8 There's no need to climb onto the JS200/210/220 to check oil levels; all routine servicing can be done from ground level.

9 Optional safety rails protect operators from falls when they're on the upper structure of the JS200/210/220.

The JS200/210/220's optional beacons can improve on-site safety still further.

10 Choose LED work lights for an even better field of vision on the JS200/210/220.



LIVELINK, WORK SMARTER

LIVELINK IS AN INNOVATIVE SOFTWARE SYSTEM THAT LETS YOU MANAGE JCB MACHINES REMOTELY – ONLINE, BY EMAIL OR BY MOBILE PHONE. ACCESS EVERYTHING FROM MACHINE ALERTS TO FUEL REPORTS AND HISTORY INFORMATION, WITH ALL DATA STORED AT A SECURE CENTRE.

Productivity and cost benefits

By providing information like idle time monitoring and machine fuel consumption, JCB Livelink helps reduce your fuel usage, saving money and improving productivity. Machine location information can help improve efficiency and perhaps even reduce insurance costs.

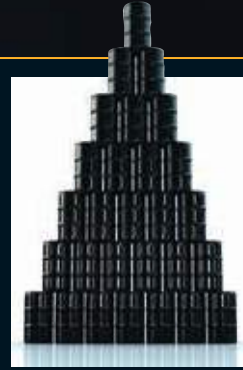

Maintenance benefits

Manage machine maintenance easily – accurate hours monitoring and service alerts improve maintenance planning, while real-time location data helps you manage your fleet. Critical machine alerts and maintenance history records are also available.



Security benefits

Livelink's real-time geofencing alerts tell you when machines move out of predetermined zones, and real-time curfew alerts inform you of unauthorised usage. Further benefits include real-time location information, advanced ECU matching (pairs Livelink with the immobiliser or ECU).



VALUE ADDED

JCB'S WORLDWIDE CUSTOMER SUPPORT IS FIRST CLASS. WHATEVER YOU NEED AND WHEREVER YOU ARE, WE'LL BE AVAILABLE QUICKLY AND EFFICIENTLY TO HELP MAKE SURE YOUR MACHINERY IS PERFORMING TO ITS FULL POTENTIAL.



1

1 Our Technical Support Service provides instant access to factory expertise, day or night, while our Finance and Insurance teams are always on hand to provide fast, flexible, competitive quotes.

2 The global network of JCB Parts Centres is another model of efficiency; with 15 regional bases, we can deliver around 95% of all parts anywhere in the world within 24 hours. Our genuine JCB parts are designed to work in perfect harmony with your machine for optimum performance and productivity.



2

3 JCB Assetcare offers comprehensive extended warranties and service agreements, as well as service-only or repair and maintenance contracts. Irrespective of what you opt for, our maintenance teams around the world charge competitive labour rates, and offer non-obligation quotations as well as fast, efficient insurance repair work.



3

Note: JCB LIVELINK and JCB ASSETCARE may not be available in your region, so please check with your local dealer.

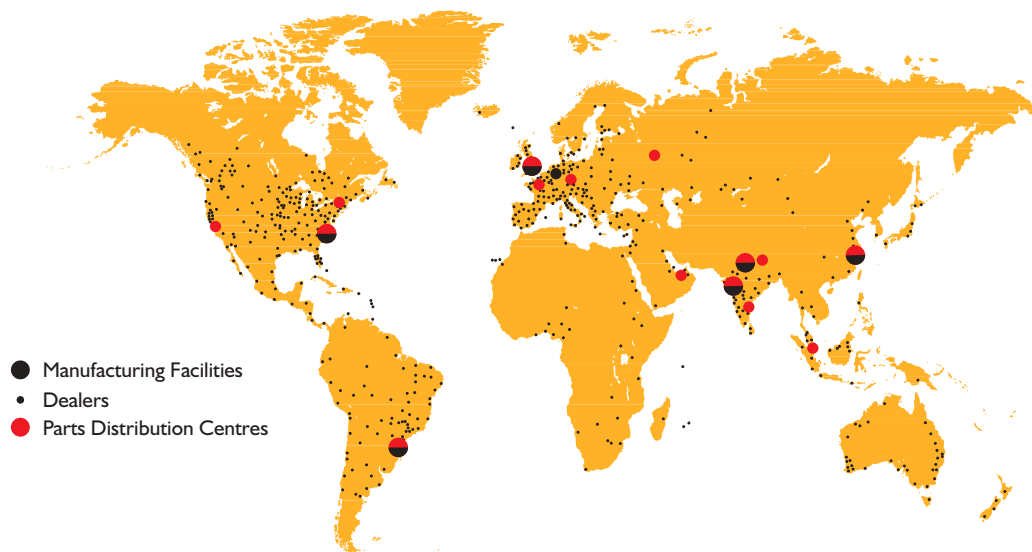

STATIC DIMENSIONS

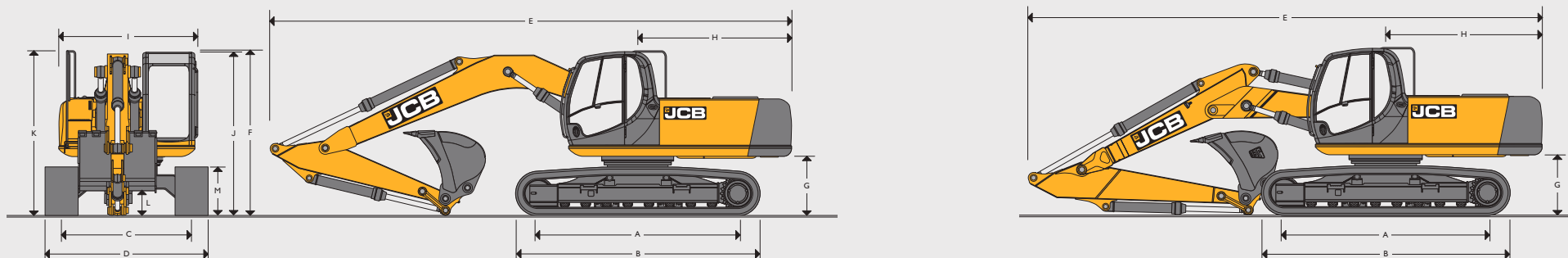

Dimensions in mm		JS200			JS210			JS220			JS220 T.A.B		
		NLC	SC	LC	NLC	LC	NLC	SC	LC	NLC	SC	LC	
A	Track CTR	3660	3370	3660	3660	3660	3660	3370	3660	3660	3370	3660	
B	Undercarriage overall length	4460	4170	4460	4460	4460	4460	4170	4460	4460	4170	4460	
C	Track gauge	1990	2170	2390	1990	2170	1990	2170	2390	1990	2170	2390	
D	Width over tracks (500mm trackshoes)	2490	2670	-	2490	-	2490	2670	-	2490	2670	-	
D	Width over tracks (600mm trackshoes)	2590	2770	2990	2590	2770	2590	2770	2990	2590	2770	2990	
D	Width over tracks (700mm trackshoes)	2690	2870	3090	2690	2870	2690	2870	3090	2690	2870	3090	
D	Width over tracks (800mm trackshoes)	2790	2970	3190	2790	2970	2790	2970	3190	2790	2970	3190	
D	Width over tracks (900mm trackshoes)	-	-	3290	-	3070	-	-	3290	-	-	-	
Dipper lengths		1.91m	2.40m	3.0m	1.91m	2.40m	3.0m	1.91m	2.40m	3.0m	1.91m	2.40m	3.0m
E	Transport length with Monoboom	9584	9584	9584	9584	9584	9584	9584	9584	9584	9600	9600	9600
F	Transport height with Monoboom	3070	3070	3070	3070	3070	3070	3070	3070	3070	3085	3085	3085
G	Counterweight clearance		1046			1046			1046			1046	
H	Tailswing radius		2825			2825			2825			2825	
I	Width of superstructure - upper		2548			2548			2548			2548	
J	Height over cab		2996			2996			2996			2996	
K	Height over grab rail		3037			3037			3037			3037	
L	Ground clearance		503			503			503			503	
M	Track height		885			885			885			885	

BUCKET AND ARM COMBINATION

JS200/210	JS220																		
	NLC			SC			LC			NLC			SC			LC			
Arm length	1.9m	2.4m	3.0m	1.9m	2.4m	3.0m	1.9m	2.4m	3.0m	1.9m	2.4m	3.0m	1.9m	2.4m	3.0m	1.9m	2.4m	3.0m	
GP Bucket 610mm, 0.34m ³	□	□	□	□	□	□	□	□	□	□	□	□	□	□	□	□	□	□	□
GP Bucket 762mm, 0.48m ³	□	□	□	□	□	□	□	□	□	□	□	□	□	□	□	□	□	□	□
GP Bucket 914mm, 0.62m ³	□	□	■	□	□	□	□	□	□	□	□	■	□	□	□	□	□	□	□
GP Bucket 1219mm, 0.89m ³	■	■	●	□	□	■	□	□	□	■	■	●	□	□	■	□	□	□	■
GP Bucket 1372mm, 1.02m ³	■	●	●	□	■	●	□	■	●	■	●	●	□	■	●	□	□	□	■
GP Bucket 1524mm, 1.20m ³	✗	✗	✗	■	●	✗	■	●	✗	■	●	●	■	■	●	□	□	□	●

□ = Suitable for general excavating (materials up to 2000kg/cu.m)
 ■ = Suitable for light excavating (materials up to 1600kg/cu.m.)
 ● = Suitable for grading & loading materials up to 1200kg/cu.m)
 ✗ = Not recommended
 * Bucket capacity recommendations with no quick hitch fitted

WEIGHTS AND GROUND BEARING PRESSURES

Figures include 1.14m³. bucket 760kg, operator, full fuel tank and 2.4m dipper.

		500mm shoes	600mm shoes	700mm shoes	800mm shoes	900mm shoes
JS200 NLC MONO						
Machine weight	kg	19845	20095	20350	–	–
Ground bearing pressure	kg/cm	0.50	0.43	0.37	–	–
JS200 SC MONO						
Machine weight	kg	19925	20180	20430	–	–
Ground bearing pressure	kg/cm	0.55	0.46	0.40	–	–
JS200 LC MONO						
Machine weight	kg	–	20605	20870	21140	21190
Ground bearing pressure	kg/cm	–	0.44	0.38	0.34	0.30
JS210 LC MONO						
Machine weight	kg	–	21090	21355	21625	21675
Ground bearing pressure	kg/cm	–	0.45	0.39	0.34	0.31
JS220 NLC MONO						
Machine weight	kg	21144	21396	21648	–	–
Ground bearing pressure	kg/cm	0.54	0.45	0.39	–	–
JS220 SC MONO						
Machine weight	kg	21227	21479	21731	–	–
Ground bearing pressure	kg/cm	0.58	0.49	0.43	–	–
JS220 LC MONO						
Machine weight	kg	–	21904	22172	22440	22490
Ground bearing pressure	kg/cm	–	0.46	0.40	0.36	0.32
JS220 NLC TAB						
Machine weight	kg	22194	22446	22698	–	–
Ground bearing pressure	kg/cm	0.56	0.47	0.41	–	–
JS220 SC TAB						
Machine weight	kg	22277	22529	22781	–	–
Ground bearing pressure	kg/cm	0.61	0.51	0.45	–	–
JS220 LC TAB						
Machine weight	kg	–	22954	23222	23490	23540
Ground bearing pressure	kg/cm	–	0.49	0.42	0.37	0.33

ENGINE

Model	JCB EcoMAX Tier4i/IIIB.
Type	4-stroke, 4-cylinder in-line, direct injection, turbocharged diesel.
Nett power (ISO 3046-1NF)	129kW (173hp)
Piston displacement	4.8 litres
Injection	Electronic injection.
Air filtration	Dry element with secondary safety element and in cab warning indicator.
Cooling	Water cooled via large capacity radiator.
Starter motor	24 volt – 4.5kW.
Batteries	2 x 12 volt Heavy-duty.
Alternator	24 volt 40 amp.
Refuelling pump	Electric type.

WORKING RANGE MONOBOOM

Boom length 5.70m					
Dipper length		1.91m	2.40m	3.00m	
A	Maximum digging reach	m	8.72	9.32	9.85
B	Maximum digging reach (on ground)	m	8.52	9.15	9.65
C	Maximum digging depth	m	5.52	5.98	6.70
D	Maximum digging height	m	8.67	8.99	9.21
E	Maximum dumping height	m	6.19	6.45	6.66
F	Maximum vertical wall cut depth	m	5.17	5.25	5.82
G	Minimum swing radius	m	3.76	3.78	3.65
	Bucket rotation	deg	183°	183°	183°
	Dipper tearout (ISO 6015)	kgf	13450	11560	9590
	Dipper tearout with boost (ISO 6015)	kgf	14610	12550	10410
	Bucket tearout (ISO 6015)	kgf	14550	14550	14550
	Bucket tearout with boost (ISO 6015)	kgf	15800	15800	15800

WORKING RANGE T.A.B

Boom length 5.70m					
Dipper length		1.91m	2.40m	3.00m	
A	Maximum digging reach	m	9.00	9.44	9.98
B	Maximum digging reach (on ground)	m	8.81	9.26	9.81
C	Maximum digging depth	m	5.25	5.72	6.29
D	Maximum digging height	m	10.24	10.61	11.00
E	Maximum dumping height	m	7.35	7.70	8.07
F	Maximum vertical wall cut depth	m	3.91	4.51	5.05
G	Minimum swing radius	m	2.50	2.55	2.29
	Bucket rotation	deg	183°	183°	183°
	Dipper tearout (ISO 6015)	kgf	13450	11560	9590
	Dipper tearout with boost (ISO 6015)	kgf	14610	12550	10410
	Bucket tearout (ISO 6015)	kgf	14550	14550	14550
	Bucket tearout with boost (ISO 6015)	kgf	15800	15800	15800

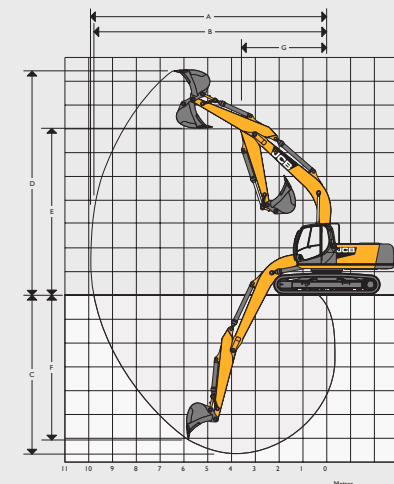







UNDERCARRIAGE		
Carriage options	SC-Standard, NC-Narrow and LC-Long Carriage.	
Recovery point	Front and rear.	
Track type	Sealed and greased.	
Track shoe options	NC & SC – 500mm (20in), 600mm (24in), 700mm (28in). LC – 600mm (24in), 700mm (28in), 800mm (31.5in), 900mm (36in).	
Upper & lower rollers	Heat treated, sealed and lubricated.	
Track adjustment	Grease cylinder type.	
Track idler	Sealed and lubricated, with spring cushioned recoil.	
	NC & SC	LC
No. of track guides	2 per side	2 per side
No. of lower rollers	7 per side	8 per side
No. of upper rollers	2 per side	2 per side
No. of track shoes	46 per side	49 per side

TRACK DRIVE	
Type	Fully hydrostatic, three speed with autoshift between high and medium speed.
Travel motors	Variable swash axial piston type, fully guarded within undercarriage frame.
Final drive	Planetary reduction, bolt-on sprockets.
Service brake	Hydraulic counter balance valve to prevent overspeeding on gradients.
Park brake	Disc type, spring applied, automatic hydraulic release
Gradeability	70% (35 deg) continuous.
Travel speed	High – 5.6 km/h (3.4 mph). Mid – 3.3 km/h (2.1 mph). Low – 2.3 km/h (1.4 mph).
Tractive effort	191.9kN (19570 kgf, 43144 lbf).

SERVICE CAPACITIES	
	JS200/210/220 (Litres)
Fuel tank	343
Radiator	25.5
Engine oil	20.4
Swing drive	5.0
Hydraulic tank	120
Final drive (each side)	4.7

SWING SYSTEM	
Swing motor	Axial piston.
Swing brake	Hydraulic braking plus automatic spring applied disc type parking brake.
Final drive	Planetary reduction.
Swing speed	12.9rpm.
Swing gear	Large diameter, internally toothed fully sealed grease bath lubricated.
Swing lock	Switchable brake in cab.

HYDRAULIC SYSTEM	
Pumps	
Main pumps	2 variable displacement axial piston type.
Maximum flow	2 x 224 L/min
Servo pump	Gear type.
Maximum flow	448 L/min
Control valve	
A combined four and five spool control valve with auxiliary service spool as standard.	
Relief valve settings	
Boom/Arm/Bucket	343 bar
With power boost	372 bar
Swing circuit	279 bar
Travel circuit	343 bar
Pilot control	40 bar
Filtration	
In tank	150 micron, suction strainer.
Main return line	10 micron, fibreform element.
Pilot line	10 micron, paper element.
Hydraulic hammer return	10 micron, reinforced microform element.

LIFT CAPACITIES – DIPPER LENGTH: 1.9M, MONOBOOM: 5.7M, TRACKSHOES: 500MM, NO BUCKET.											JS200 NLC MONO
Reach	3m		4.5m		6m		7.5m		Capacity at Max Reach		
											
Load Point Ht.	kg	kg	kg	kg	kg	kg	kg	kg	kg	kg	mm
6.0m					6230*	4020			6270*	3810	6191
4.5m			7840*	5990	6580*	3910			5660	3070	6983
3.0m			9720*	5510	7030	3720			5090	2740	7390
1.5m					6820	3540			4920	2620	7477
0m			10600	5060	6710	3440			5100	2690	7255
- 1.5m			10620*	5080	6700	3440			5730	3000	6693
- 3.0m	12870*	9750	9660*	5200					7400	3810	5690

LIFT CAPACITIES – DIPPER LENGTH: 2.4M, MONOBOOM: 5.7M, TRACKSHOES: 500MM, NO BUCKET.											JS200 NLC MONO
Reach	3m		4.5m		6m		7.5m		Capacity at Max Reach		
											
Load Point Ht.	kg	kg	kg	kg	kg	kg	kg	kg	kg	kg	mm
6.0m					5630*	4080			5290*	3320	6755
4.5m			7130*	6090	6110*	3940			5070	2750	7486
3.0m			9020*	5600	6940*	3730	4980	2670	4610	2470	7868
1.5m			10630*	5200	6820	3530	4880	2580	4470	2370	7949
0m			10550	5010	6670	3400	4810	2520	4600	2420	7741
- 1.5m	10630*	9340	10520	4990	6620	3360			5080	2650	7218
- 3.0m	14070*	9520	10190*	5070	6700	3430			6260	3240	6300
- 4.5m	10600*	9900	7520*	5340					6930*	4950	4760











LIFT CAPACITIES – DIPPER LENGTH: 3.0M, MONOBOOM: 5.7M, TRACKSHOES: 500MM, NO BUCKET.											JS200 NLC MONO
Reach	3m		4.5m		6m		7.5m		Capacity at Max Reach		
											
Load Point Ht.	kg	kg	kg	kg	kg	kg	kg	kg	kg	kg	mm
7.5m					4540*	4160			3900*	3890	6226
6.0m									3660*	2930	7332
4.5m					5530*	3990	5100	2770	3630*	2470	8011
3.0m	11850*	10360	8140*	5720	6420*	3760	4990	2670	3750*	2230	8367
1.5m			9960*	5250	6830	3530	4860	2560	4020*	2130	8444
0m	6310*	6310*	10530	4980	6630	3360	4760	2470	4150	2160	8249
- 1.5m	10480*	9100	10420	4890	6540	3290	4720	2440	4510	2330	7760
- 3.0m	15210*	9250	10470	4930	6570	3310			5350	2760	6916
- 4.5m	12430*	9570	8850*	5110					6850*	3850	5552

 Lift capacity front and rear.





 Lift capacity full circle.

- Notes:
1. For lifting capacity including bucket, subtract total weight of bucket or bucket and quickhitch from above values.
 2. Lifting capacities are based on ISO 10567, that is: 75% of minimum tipping load or 87% of hydraulic lift capacity, whichever is the less. Lifting capacities marked* are based on hydraulic capacity.
 3. Lift capacities assume that the machine is on firm, level ground.
 4. Lift capacities may be limited by local regulations. Please refer to your dealer.









LIFT CAPACITIES – DIPPER LENGTH: 1.9M, MONOBOOM: 5.7M, TRACKSHOES: 600MM, NO BUCKET.**JS200 SC MONO**

Reach	3m		4.5m		6m		7.5m		Capacity at Max Reach		mm
											
Load Point Ht.	kg	kg	kg	kg	kg	kg	kg	kg	kg	kg	mm
6.0m					6230*	4430			6270*	4200	6191
4.5m			7840*	6660	6540	4320			5130	3400	6983
3.0m			9720*	6160	6320	4130			4610	3040	7390
1.5m					6130	3950			4450	2920	7477
0m			9340	5700	6010	3850			4600	3000	7255
- 1.5m			9360	5720	6010	3840			5160	3340	6693
- 3.0m	12870*	11190	9510	5850					6630	4250	5690

LIFT CAPACITIES – DIPPER LENGTH: 2.40M, 5.70M MONOBOOM, TRACKSHOES: 600MM, NO BUCKET.**JS200 SC MONO**

Reach	3m		4.5m		6m		7.5m		Capacity at Max Reach		mm
											
Load Point Ht.	kg	kg	kg	kg	kg	kg	kg	kg	kg	kg	mm
6.0m					5630*	4490			5290*	3670	6755
4.5m			7130*	6770	6110*	4350			4600	3050	7486
3.0m			9020*	6260	6350	4140	4510	2970	4180	2750	7868
1.5m			9510	5840	6120	3940	4410	2880	4040	2640	7949
0m			9290	5650	5970	3810	4340	2810	4150	2700	7741
- 1.5m	10630*	10630*	9260	5620	5930	3770			4580	2960	7218
- 3.0m	14070*	10950	9370	5710	6010	3840			5620	3610	6300
- 4.5m	10600*	10600*	7520*	5990					6930*	5540	4760

LIFT CAPACITIES – DIPPER LENGTH: 3.0M, MONOBOOM: 5.7M, TRACKSHOES: 600MM, NO BUCKET.**JS200 SC MONO**

Reach	3m		4.5m		6m		7.5m		Capacity at Max Reach		mm
											
Load Point Ht.	kg	kg	kg	kg	kg	kg	kg	kg	kg	kg	mm
7.5m					4540*	4540*			3900*	3900*	6226
6.0m									3660*	3240	7332
4.5m					5530*	4410	4630	3070	3630*	2740	8011
3.0m	11850*	11840	8140*	6390	6390	4170	4510	2970	3750*	2480	8367
1.5m			9590	5900	6130	3940	4390	2850	3670	2380	8444
0m	6310*	6310*	9260	5610	5940	3770	4290	2760	3740	2420	8249
- 1.5m	10480*	10480*	9160	5520	5850	3690	4260	2730	4060	2610	7760
- 3.0m	15210*	10670	9210	5570	5880	3710			4820	3090	6916
- 4.5m	12430*	11010	8850*	5760					6790	4300	5552

 Lift capacity front and rear.

 Lift capacity full circle.
Notes:

1. For lifting capacity including bucket, subtract total weight of bucket or bucket and quickhitch from above values.
2. Lifting capacities are based on ISO 10567, that is: 75% of minimum tipping load or 87% of hydraulic lift capacity, whichever is the less. Lifting capacities marked* are based on hydraulic capacity.
3. Lift capacities assume that the machine is on firm, level ground.
4. Lift capacities may be limited by local regulations. Please refer to your dealer.

LIFT CAPACITIES – DIPPER LENGTH: 1.9M, MONOBOOM: 5.7M, TRACKSHOES: 700MM, NO BUCKET.											JS200 LC MONO
Reach	3m		4.5m		6m		7.5m		Capacity at Max Reach		
											
Load Point Ht.	kg	kg	kg	kg	kg	kg	kg	kg	kg	kg	mm
6.0m					6360*	6360*			6270*	4700	6191
4.5m			7840*	7500	6580*	4850			5870	3820	6983
3.0m			9720*	6990	7290	4650			5290	3420	7390
1.5m					7080	4470			5120	3290	7477
0m			11010	6510	6970	4360			5300	3390	7255
- 1.5m			11000*	6530	6960	4350			5950	3780	6693
- 3.0m	12870*	12870*	9660*	6660					7410*	4810	5690











LIFT CAPACITIES – DIPPER LENGTH: 2.4M, MONOBOOM: 5.7M, TRACKSHOES: 700MM, NO BUCKET.											JS200 LC MONO
Reach	3m		4.5m		6m		7.5m		Capacity at Max Reach		
											
Load Point Ht.	kg	kg	kg	kg	kg	kg	kg	kg	kg	kg	mm
6.0m					5630*	5020			5290*	4110	6755
4.5m			7130*	7130*	6110*	4880			5210*	3430	7486
3.0m			9020*	7080	6940*	4660	5170	3340	4790	3100	7868
1.5m			10630*	6660	7080	4450	5070	3250	4650	2990	7949
0m			10960	6460	6930	4320	5000	3190	4780	3060	7741
- 1.5m	10630	10630*	10930	6430	6880	4280			5280	3360	7218
- 3.0m	14070*	12770	10190*	6530	6970	4350			6500	4090	6300
- 4.5m	10600*	10600*	7520*	6810					6930*	6290	4760









LIFT CAPACITIES – DIPPER LENGTH: 3.0M, MONOBOOM: 5.7M, TRACKSHOES: 700MM, NO BUCKET.											JS200 LC MONO
Reach	3m		4.5m		6m		7.5m		Capacity at Max Reach		
											
Load Point Ht.	kg	kg	kg	kg	kg	kg	kg	kg	kg	kg	mm
7.5m					4540	4540*			3900*	3900*	6226
6.0m									3660*	3630	7332
4.5m					5530*	4940	5230*	3450	3630*	3080	8011
3.0m	11850*	11850*	8140*	7220	6420*	4700	5180	3350	3750*	2810	8367
1.5m			9960*	6710	7090	4460	5050	3230	4020*	2700	8444
0m	6310*	6310*	10930	6430	6890	4280	4950	3140	4320	2750	8249
- 1.5m	10480*	10480*	10820	6330	6800	4200	4910	3100	4690	2970	7760
- 3.0m	15210*	12480	10630*	6380	6830	4220			5570	3510	6916
- 4.5m	12430*	12430*	8850*	6570					6850*	4880	5552



 Lift capacity front and rear.

 Lift capacity full circle.

- Notes:
1. For lifting capacity including bucket, subtract total weight of bucket or bucket and quickhitch from above values.
 2. Lifting capacities are based on ISO 10567, that is: 75% of minimum tipping load or 87% of hydraulic lift capacity, whichever is the less. Lifting capacities marked* are based on hydraulic capacity.
 3. Lift capacities assume that the machine is on firm, level ground.
 4. Lift capacities may be limited by local regulations. Please refer to your dealer.

LIFT CAPACITIES – DIPPER LENGTH: 1.9M, MONOBOOM 5.7M, TRACKSHOES: 500MM, NO BUCKET											JS210 NLC MONO
Reach	3m		4.5m		6m		7.5m		Capacity at Max Reach		
											
Load Point Ht.	kg	kg	kg	kg	kg	kg	kg	kg	kg	kg	mm
6.0m					6230*	4350			6270*	4120	6191
4.5m			7840*	6470	6580*	4240			6040	3350	6983
3.0m			9720*	5990	7340*	4050			5440	3000	7390
1.5m					7290	3870			5270	2880	7477
0m			11330	5540	7170	3770			5450	2950	7255
- 1.5m			11000*	5550	7160	3770			6130	3290	6693
- 3.0m	12870*	10600	9660*	5680					7410*	4160	5690

LIFT CAPACITIES – DIPPER LENGTH: 2.4M, MONOBOOM 5.7M, TRACKSHOES: 500MM, NO BUCKET.											JS210 NLC MONO
Reach	3m		4.5m		6m		7.5m		Capacity at Max Reach		
											
Load Point Ht.	kg	kg	kg	kg	kg	kg	kg	kg	kg	kg	mm
6.0m					5630*	4400			5290*	3610	6755
4.5m			7130*	6570	6110*	4270			5210*	3000	7486
3.0m			9020*	6070	6940*	4060	5320	2920	4940	2710	7868
1.5m			10630*	5670	7290	3860	5220	2830	4790	2610	7949
0m			11280	5490	7130	3730	5150	2770	4930	2660	7741
- 1.5m	10630*	10190	11170*	5460	7090	3690			5440	2920	7218
- 3.0m	14070*	10370	10190*	5550	7170	3760			6690	3550	6300
- 4.5m	10600*	10600*	7520*	5810					6930*	5400	4760

LIFT CAPACITIES – DIPPER LENGTH: 3.0M, MONOBOOM 5.7M, TRACKSHOES: 500MM, NO BUCKET.											JS210 NLC MONO
Reach	3m		4.5m		6m		7.5m		Capacity at Max Reach		
											
Load Point Ht.	kg	kg	kg	kg	kg	kg	kg	kg	kg	kg	mm
7.5m					4540*	4490			3900*	3900*	6226
6.0m									3660*	3190	7332
4.5m					5530*	4320	5230*	3030	3630*	2700	8011
3.0m	11850*	11200	8140*	6200	6420*	4090	5330	2930	3750*	2450	8367
1.5m			9960*	5720	7300	3860	5200	2810	4020*	2350	8444
0m	6310*	6310*	11020*	5450	7100	3690	5100	2720	4450	2390	8249
- 1.5m	10480*	9950	11140	5360	7010	3620	5070	2690	4830	2580	7760
- 3.0m	15210*	10100	10630*	5400	7040	3640			5740	3040	6916
- 4.5m	8850*	10420	8850*	5590					6850*	4210	5552

 Lift capacity front and rear.

 Lift capacity full circle.

Notes:

1. For lifting capacity including bucket, subtract total weight of bucket or bucket and quickhitch from above values.
2. Lifting capacities are based on ISO 10567, that is: 75% of minimum tipping load or 87% of hydraulic lift capacity, whichever is the less. Lifting capacities marked* are based on hydraulic capacity.
3. Lift capacities assume that the machine is on firm, level ground.
4. Lift capacities may be limited by local regulations. Please refer to your dealer.











LIFT CAPACITIES – DIPPER LENGTH: 1.9M, MONOBOOM 5.7M, TRACKSHOES: 700MM, NO BUCKET. JS210 LC MONO

Reach	3m		4.5m		6m		7.5m		Capacity at Max Reach		mm
											
Load Point Ht.	kg	kg	kg	kg	kg	kg	kg	kg	kg	kg	
6.0m					6230*	5350			6270*	5080	6191
4.5m			7840*	7840*	6580*	5240			6280	4150	6983
3.0m			9720*	7560	7340*	5040			5670	3730	7390
1.5m					7590	4860			5490	3590	7477
0m			11430*	7090	7470	4750			5680	3700	7255
- 1.5m			11000*	7100	7460	4750			6390	4120	6693
- 3.0m	12870*	12870*	9660*	7240					7410*	5230	5690

LIFT CAPACITIES – DIPPER LENGTH: 2.4M, MONOBOOM 5.7M, TRACKSHOES: 700MM, NO BUCKET. JS210 LC MONO

Reach	3m		4.5m		6m		7.5m		Capacity at Max Reach		mm
											
Load Point Ht.	kg	kg	kg	kg	kg	kg	kg	kg	kg	kg	
6.0m					5630*	5320			5290*	4370	6755
4.5m			7130*	7130*	6110*	5180			5210*	3660	7486
3.0m			9020*	7530	6940*	4960	5460	3570	5060	3320	7868
1.5m			10630*	7100	7470	4760	5350	3480	4910	3200	4949
0m			11320*	6900	7320	4620	5290	3420	5060	3280	7741
- 1.5m	10630*	10630*	11170*	6880	7270	4580			5580	3600	7218
- 3.0m	14070*	13610	10190*	6970	7350	4660			6860	4380	6300
- 4.5m	10600*	10600*	7520*	7250					6930*	6700	4760

LIFT CAPACITIES – DIPPER LENGTH: 3.0M, MONOBOOM 5.7M, TRACKSHOES: 700MM, NO BUCKET. JS210 LC MONO

Reach	3m		4.5m		6m		7.5m		Capacity at Max Reach		mm
											
Load Point Ht.	kg	kg	kg	kg	kg	kg	kg	kg	kg	kg	
7.5m					4540*	4540*			3900*	3900*	6226
6.0m									3660*	3660*	7332
4.5m					5530*	5330	5230*	3750	3630*	3360	8011
3.0m	11850*	11850*	8140*	7800	6420*	5090	5550	3650	3750*	3070	8367
1.5m			9960*	7290	7350*	4850	5420	3530	4020*	2960	8444
0m	6310*	6310*	11020*	7000	7400	4680	5320	3440	4500*	3010	8249
- 1.5m	10480*	10480*	11220*	6910	7310	4590	5290	3400	5040	3260	7760
- 3.0m	15210*	13570	10630*	6950	7340	4620			5980	3830	6916
- 4.5m	12430*	12430*	8850*	7150					6850*	5320	5552

 Lift capacity front and rear.

 Lift capacity full circle.

Notes:

1. For lifting capacity including bucket, subtract total weight of bucket or bucket and quickhitch from above values.
2. Lifting capacities are based on ISO 10567, that is: 75% of minimum tipping load or 87% of hydraulic lift capacity, whichever is the less. Lifting capacities marked* are based on hydraulic capacity.
3. Lift capacities assume that the machine is on firm, level ground.
4. Lift capacities may be limited by local regulations. Please refer to your dealer.

LIFT CAPACITIES – DIPPER LENGTH: 1.9M, MONOBOOM 5.7M, TRACKSHOES: 500MM, NO BUCKET.

JS220 NLC MONO

Reach	3m		4.5m		6m		7.5m		Capacity at Max Reach		mm
											
Load Point Ht.	kg	kg	kg	kg	kg	kg	kg	kg	kg	kg	mm
6.0m					6230*	4730			6270*	4490	6191
4.5m			7840*	7020	6580*	4620			6300*	3670	6983
3.0m			9720*	6540	7340*	4430			5850	3300	7390
1.5m					7830	4260			5670	3170	7477
0m			11430*	6090	7720	4160			5870	3260	7255
- 1.5m			11000*	6110	7710	4150			6600	3630	6693
- 3.0m	12870*	11590	9660*	6230					7410*	4570	5690

LIFT CAPACITIES – DIPPER LENGTH: 2.4M, MONOBOOM 5.7M, TRACKSHOES: 500MM, NO BUCKET.

JS220 NLC MONO

Reach	3m		4.5m		6m		7.5m		Capacity at Max Reach		mm
											
Load Point Ht.	kg	kg	kg	kg	kg	kg	kg	kg	kg	kg	mm
6.0m					5630*	4790			5290*	3940	6755
4.5m			7130*	7120	6110*	4650			5210*	3300	7486
3.0m			9020*	6630	6940*	4450	5720	3220	5310	2990	7868
1.5m			10630*	6230	7770*	4250	5620	3130	5160	2880	7949
0m			11320*	6040	7680	4120	5550	3070	5310	2940	7741
- 1.5m	10630*	10630*	11170*	6020	7630	4080			5860	3220	7218
- 3.0m	14070*	11360	10190*	6100	7490*	4150			6950*	3910	6300
- 4.5m	10600*	10600*	7520*	6370					6930*	5910	4760

LIFT CAPACITIES – DIPPER LENGTH: 3.0M, MONOBOOM 5.7M, TRACKSHOES: 500MM, NO BUCKET.

JS220 NLC MONO

Reach	3m		4.5m		6m		7.5m		Capacity at Max Reach		mm
											
Load Point Ht.	kg	kg	kg	kg	kg	kg	kg	kg	kg	kg	mm
6.0m									3660*	3490	7332
4.5m					5530*	4710	5230*	3320	3630*	2970	8011
3.0m	11850*	11850*	8140*	6750	6420*	4480	5620*	3220	3750*	2710	8367
1.5m			9960*	6280	7350*	4240	5600	3110	4020*	2610	8444
0m	6310*	6310*	11020*	6000	7650	4080	5500	3020	4500*	2650	8249
- 1.5m	10480*	10480*	11220*	5920	7560	4000	5470	2980	5220	2860	7760
- 3.0m	15210*	11090	10630*	5960	7580	4020			6180	3360	6916
- 4.5m	12430*	11410	8850*	6140					6850*	4630	5552

 Lift capacity front and rear.

 Lift capacity full circle.

Notes:

1. For lifting capacity including bucket, subtract total weight of bucket or bucket and quickhitch from above values.
2. Lifting capacities are based on ISO 10567, that is: 75% of minimum tipping load or 87% of hydraulic lift capacity, whichever is the less. Lifting capacities marked* are based on hydraulic capacity.
3. Lift capacities assume that the machine is on firm, level ground.
4. Lift capacities may be limited by local regulations. Please refer to your dealer.

LIFT CAPACITIES – DIPPER LENGTH: 1.9M, MONOBOOM 5.7M, TRACKSHOES: 600MM, NO BUCKET											JS220 SC MONO
Reach	3m		4.5m		6m		7.5m		Capacity at Max Reach		
											
Load Point Ht.	kg	kg	kg	kg	kg	kg	kg	kg	kg	kg	mm
6.0m					6230*	5180			6270*	4920	6191
4.5m			7840*	7750	6580*	5070			5900	4030	6983
3.0m			9720*	7260	7270	4880			5320	3620	7390
1.5m					7070	4700			5160	3490	7477
0m			10790	6790	6960	4600			5330	3590	7255
- 1.5m			10810	6810	6950	4590			5980	4000	6693
- 3.0m	12870*	12870*	9660*	6940					7410*	5050	5690

LIFT CAPACITIES – DIPPER LENGTH: 2.4M, MONOBOOM 5.7M, TRACKSHOES: 600MM, NO BUCKET.											JS220 SC MONO
Reach	3m		4.5m		6m		7.5m		Capacity at Max Reach		
											
Load Point Ht.	kg	kg	kg	kg	kg	kg	kg	kg	kg	kg	mm
6.0m					5630*	5240			5290*	4320	6755
4.5m			7130*	7130*	6110*	5110			5210*	3620	7486
3.0m			9020*	7350	6940*	4890	5210	3540	4840	3290	7868
1.5m			10630*	6930	7070	4690	5110	3450	4700	3180	7949
0m			10740	6740	6920	4560	5040	3390	4830	3250	7741
- 1.5m	10630*	10630*	10710	6720	6870	4520			5310	3560	7218
- 3.0m	14070*	12960	10190*	6810	6960	4590			6500	4320	6300
- 4.5m	10600*	10600*	7520*	7080					6930*	6560	4760

LIFT CAPACITIES – DIPPER LENGTH: 3.0M, MONOBOOM 5.7M, TRACKSHOES: 600MM, NO BUCKET.											JS220 SC MONO
Reach	3m		4.5m		6m		7.5m		Capacity at Max Reach		
											
Load Point Ht.	kg	kg	kg	kg	kg	kg	kg	kg	kg	kg	mm
6.0m									3660*	3660*	7332
4.5m					5530*	5160	5230*	3650	3630*	3270	8011
3.0m	11850*	11850*	8140*	7480	6420*	4930	5220	3540	3750*	2990	8367
1.5m			9960*	6990	7080	4690	5090	3430	4020*	2880	8444
0m	6310*	6310*	10710	6710	6880	4520	4990	3340	4370	2930	8249
- 1.5m	10480*	10480*	10600	6620	6800	4440	4960	3300	4730	3160	7760
- 3.0m	15210*	12680	10630*	6660	6820	4460			5590	3720	6916
- 4.5m	12430*	12430*	8850*	6850					6850*	5130	5552

 Lift capacity front and rear.

 Lift capacity full circle.

Notes:

1. For lifting capacity including bucket, subtract total weight of bucket or bucket and quickhitch from above values.
2. Lifting capacities are based on ISO 10567, that is: 75% of minimum tipping load or 87% of hydraulic lift capacity, whichever is the less. Lifting capacities marked* are based on hydraulic capacity.
3. Lift capacities assume that the machine is on firm, level ground.
4. Lift capacities may be limited by local regulations. Please refer to your dealer.

LIFT CAPACITIES – DIPPER LENGTH: 1.9M, MONOBOOM 5.7M, TRACKSHOES: 700MM, NO BUCKET. JS220 LC MONO

Reach	3m		4.5m		6m		7.5m		Capacity at Max Reach		mm
											
Load Point Ht.	kg	kg	kg	kg	kg	kg	kg	kg	kg	kg	mm
6.0m					6230*	5740			6270*	5460	6191
4.5m			7840*	7840*	6580*	5630			6300*	4470	6983
3.0m			9720*	8140	7340*	5430			6050	4030	7390
1.5m					8060*	5250			5860	3890	7477
0m			11430*	7660	7980	5150			6070	4010	7255
- 1.5m			11000*	7680	7970	5140			6820	4470	6693
- 3.0m	12870*	12870*	9660*	7810					7410*	5650	5690

LIFT CAPACITIES – DIPPER LENGTH: 2.4M, MONOBOOM 5.7M, TRACKSHOES: 700MM, NO BUCKET. JS220 LC MONO

Reach	3m		4.5m		6m		7.5m		Capacity at Max Reach		mm
											
Load Point Ht.	kg	kg	kg	kg	kg	kg	kg	kg	kg	kg	mm
6.0m					5630*	5630*			5290*	4790	6755
4.5m			7130*	7130*	6110*	5670			5210*	4030	7486
3.0m			9020*	8240	6940*	5450	5910	3940	5350*	3660	7868
1.5m			10630*	7810	7770*	5240	5810	3850	5340	3540	7949
0m			11320*	7620	7940	5110	5740	3780	5500	3630	7741
- 1.5m	10630*	10630*	11170*	7590	7890	5070			6060	3980	7218
- 3.0m	14070*	14070*	10190*	7680	7490*	5140			6950*	4830	6300
- 4.5m	10600*	10600*	7520*	7520*					6390*	6390*	4760

LIFT CAPACITIES – DIPPER LENGTH: 3.0M, MONOBOOM 5.7M, TRACKSHOES: 700MM, NO BUCKET. JS220 LC MONO







Reach	3m		4.5m		6m		7.5m		Capacity at Max Reach		mm
											
Load Point Ht.	kg	kg	kg	kg	kg	kg	kg	kg	kg	kg	mm
6.0m									3660*	3660*	7332
4.5m					5530*	5530*	5230*	4050	3630*	3630	8011
3.0m	11850*	11850*	8140*	8140*	6420*	5480	5620*	3940	3750*	3330	8367
1.5m			9960*	7870	7350*	5240	5800	3830	4020*	3220	8444
0m	6310*	6310*	11020*	7580	7910	5070	5700	3730	4500*	3280	8249
- 1.5m	10480*	10480*	11220*	7490	7820	4990	5660	3700	5370*	3540	7760
- 3.0m	15210*	14650	10630*	7530	7840	5010			6400	4160	6916
- 4.5m	12430*	12430*	8850*	7720					6850*	5750	5552

 Lift capacity front and rear.

 Lift capacity full circle.

Notes:

1. For lifting capacity including bucket, subtract total weight of bucket or bucket and quickhitch from above values.
2. Lifting capacities are based on ISO 10567, that is: 75% of minimum tipping load or 87% of hydraulic lift capacity, whichever is the less. Lifting capacities marked* are based on hydraulic capacity.
3. Lift capacities assume that the machine is on firm, level ground.
4. Lift capacities may be limited by local regulations. Please refer to your dealer.

LIFT CAPACITIES – DIPPER LENGTH: 1.9M, T.A. BOOM 5.7M, TRACKSHOES: 500MM, NO BUCKET.											JS220 NLC T.A.B.
Reach	3m		4.5m		6m		7.5m		Capacity at Max Reach		
											
Load Point Ht.	kg	kg	kg	kg	kg	kg	kg	kg	kg	kg	mm
7.5m									6350*	6350*	4193
6.0m			7250*	7250*					5890	5170	5715
4.5m	11970*	11970*	8350*	7170	7030*	4690			5960*	4080	6565
3.0m			9980*	6630	7320	4480			5800	3590	6998
1.5m			10920	6210	7090	4280			5570	3420	7089
0m			10710	6030	6940	4150			5760	3500	6855
- 1.5m	13950*	11140	10660*	6020	6920	4130			6530	3920	6256
- 3.0m			8840*	6160					7590*	5130	5167

LIFT CAPACITIES – DIPPER LENGTH: 2.4M, T.A. BOOM 5.7M, TRACKSHOES: 500MM, NO BUCKET.											JS220 NLC T.A.B.
Reach	3m		4.5m		6m		7.5m		Capacity at Max Reach		
											
Load Point Ht.	kg	kg	kg	kg	kg	kg	kg	kg	kg	kg	mm
7.5m									5300*	5300*	5080
6.0m			6580*	6580*	6250*	4890			4890*	4400	6391
4.5m	10330*	10330*	7710*	7320	6600*	4760			4850*	3610	7160
3.0m			9400*	6780	7320*	4540	5250	3270	5040*	3230	7558
1.5m			10830*	6310	7130	4310	5150	3170	5010	3090	7643
0m	6700*	6700*	10740	6060	6950	4160			5140	3140	7426
- 1.5m	13480*	11020	10660	6000	6880	4090			5690	3450	6879
- 3.0m	13060*	11200	9630*	6070					7040*	4250	5907

LIFT CAPACITIES – DIPPER LENGTH: 3.0M, T.A. BOOM 5.7M, TRACKSHOES: 500MM, NO BUCKET.											JS220 NLC T.A.B.
Reach	3m		4.5m		6m		7.5m		Capacity at Max Reach		
											
Load Point Ht.	kg	kg	kg	kg	kg	kg	kg	kg	kg	kg	mm
7.5m									3530*	3530*	5811
6.0m					5440*	5010			3320*	3320*	6984
4.5m			6870*	6870*	6070*	4860	4120*	3420	3300*	3270	7694
3.0m	13270*	12630	8620*	6960	6860*	4610	5310	3320	3430*	2960	8065
1.5m	6990*	6990*	10290*	6430	7180	4360	5170	3190	3710*	2830	8145
0m	8570*	8570*	10790	6090	6960	4160	5060	3090	4220*	2860	7942
- 1.5m	12600*	10880	10620	5950	6840	4060			5070	3080	7433
- 3.0m	14500*	11000	10290*	5970	6850	4070			6070	3650	6545
- 4.5m			7870*	6150					6750*	5230	5082

 Lift capacity front and rear.

 Lift capacity full circle.

Notes:

1. For lifting capacity including bucket, subtract total weight of bucket or bucket and quickhitch from above values.
2. Lifting capacities are based on ISO 10567, that is: 75% of minimum tipping load or 87% of hydraulic lift capacity, whichever is the less. Lifting capacities marked* are based on hydraulic capacity.
3. Lift capacities assume that the machine is on firm, level ground.
4. Lift capacities may be limited by local regulations. Please refer to your dealer.

LIFT CAPACITIES – DIPPER LENGTH: 1.9M, T.A. BOOM 5.7M, TRACKSHOES: 600MM, NO BUCKET.

JS220 SC T.A.B.

Reach	3m		4.5m		6m		7.5m		Capacity at Max Reach		mm
											
Load Point Ht.	kg	kg	kg	kg	kg	kg	kg	kg	kg	kg	mm
7.5m									6350*	6350*	4193
6.0m			7250*	7250*					5890*	5710	5175
4.5m	11970*	11970*	8350*	7980	7030*	5190			5960*	4510	6565
3.0m			9980*	7420	7410	4980			5870	3990	6998
1.5m			11060	6990	7180	4770			5640	3800	7089
0m			10850	6800	7040	4640			5830	3900	6855
- 1.5m	13950*	12840	10660*	6790	7010	4620			6620	4380	6256
- 3.0m			8840*	6930					7590*	5750	5167











LIFT CAPACITIES – DIPPER LENGTH: 2.4M, T.A. BOOM 5.7M, TRACKSHOES: 600MM, NO BUCKET.

JS220 SC T.A.B.

Reach	3m		4.5m		6m		7.5m		Capacity at Max Reach		mm
											
Load Point Ht.	kg	kg	kg	kg	kg	kg	kg	kg	kg	kg	mm
7.5m									5300*	5300*	5080
6.0m			6580*	6580*	6250*	5390			4890*	4850	6391
4.5m	10330*	10330*	7710*	7710*	6600*	5260			4850*	3990	7160
3.0m			9400*	7580	7320*	5040	5320	3630	5040*	3580	7558
1.5m			10830*	7090	7220	4810	5220	3530	5070	3430	7643
0m	6700*	6700*	10890	6830	7040	4640			5210	3500	7426
- 1.5m	13480*	12720	10810	6760	6970	4580			5760	3850	6879
- 3.0m	13060*	12920	9630*	6840					7040*	4750	5907

LIFT CAPACITIES – DIPPER LENGTH: 3.0M, T.A. BOOM 5.7M, TRACKSHOES: 600MM, NO BUCKET.

JS220 SC T.A.B.







Reach	3m		4.5m		6m		7.5m		Capacity at Max Reach		mm
											
Load Point Ht.	kg	kg	kg	kg	kg	kg	kg	kg	kg	kg	mm
7.5m									3530*	3530*	5811
6.0m					5440*	5440*			3320*	3320*	6984
4.5m			6870*	6870*	6070*	5360	4120*	3780	3300*	3300*	7694
3.0m	13270*	13270*	8620*	7760	6860*	5110	5380	3670	3430*	3280	8065
1.5m	6990*	6990*	10290*	7210	7280	4850	5240	3550	3710*	3140	8145
0m	8570*	8570*	10930	6860	7050	4650	5130	3440	4220*	3180	7942
- 1.5m	12600*	12570	10760	6720	6940	4540			5140	3440	7433
- 3.0m	14500*	12710	10290*	6740	6950	4550			6150	4080	6545
- 4.5m			7870*	6930					6750*	5870	5082

 Lift capacity front and rear.

 Lift capacity full circle.

Notes:

1. For lifting capacity including bucket, subtract total weight of bucket or bucket and quickhitch from above values.
2. Lifting capacities are based on ISO 10567, that is: 75% of minimum tipping load or 87% of hydraulic lift capacity, whichever is the less. Lifting capacities marked* are based on hydraulic capacity.
3. Lift capacities assume that the machine is on firm, level ground.
4. Lift capacities may be limited by local regulations. Please refer to your dealer.

LIFT CAPACITIES – DIPPER LENGTH: 1.9M, T.A. BOOM 5.7M, TRACKSHOES: 700MM, NO BUCKET.											JS220 LC T.A.B.
Reach	3m		4.5m		6m		7.5m		Capacity at Max Reach		
											
Load Point Ht.	kg	kg	kg	kg	kg	kg	kg	kg	kg	kg	mm
7.5m									6350*	6350*	4193
6.0m			7250*	7250*					5890*	5890*	5715
4.5m	11970*	11970*	8350*	8350*	7030*	5750			5960*	5000	6565
3.0m			9980*	8310	7650*	5530			6360*	4430	6998
1.5m			11160*	7860	8210	5320			6410	4240	7089
0m			11340*	7670	8060	5190			6650	4350	6855
- 1.5m	13950*	13950*	10660*	7660	7960*	5170			7550	4900	6256
- 3.0m			8840*	7800					7590*	6440	5167

LIFT CAPACITIES – DIPPER LENGTH: 2.4M, T.A. BOOM 5.7M, TRACKSHOES: 700MM, NO BUCKET.											JS220 LC T.A.B.
Reach	3m		4.5m		6m		7.5m		Capacity at Max Reach		
											
Load Point Ht.	kg	kg	kg	kg	kg	kg	kg	kg	kg	kg	mm
7.5m									5300*	5300*	5080
6.0m			6580*	6580*	6250*	5950			4890*	4890*	6391
4.5m	10330*	10330*	7710*	7710*	6600*	5820			4850*	4420	7160
3.0m			9400*	8470	7320*	5590	5520*	4030	5040*	3980	7558
1.5m			10830*	7970	8020*	5360	5920	3930	5490*	3820	7643
0m	6700*	6700*	11360*	7700	8060	5190			5920	3910	7426
- 1.5m	13480*	13480*	11000*	7630	7990	5130			6570	4290	6879
- 3.0m	13060*	13060*	9630*	7710					7040*	5310	5907

LIFT CAPACITIES – DIPPER LENGTH: 3.0M, T.A. BOOM 5.7M, TRACKSHOES: 700MM, NO BUCKET.											JS220 LC T.A.B.
Reach	3m		4.5m		6m		7.5m		Capacity at Max Reach		
											
Load Point Ht.	kg	kg	kg	kg	kg	kg	kg	kg	kg	kg	mm
7.5m									3530*	3530*	5811
6.0m					5440*	5440*			3320*	3320*	6984
4.5m			6870*	6870*	6070*	5920	4120*	4120*	3300*	3300*	7694
3.0m	13270*	13270*	8620*	8620*	6860*	5670	5780*	4080	3430*	3430*	8065
1.5m	6990*	6990*	10290*	8090	7680*	5400	5940	3950	3710*	3500	8145
0m	8570*	8570*	11190*	7740	8080	5200	5830	3840	4220*	3550	7942
- 1.5m	12600*	12600*	11200*	7590	7950	5090			5160*	3840	7433
- 3.0m	14500*	14500*	10290*	7610	7600*	5100			6730*	4560	6545
- 4.5m			7870*	7800					6750*	6580	5082

 Lift capacity front and rear.

 Lift capacity full circle.

Notes:

1. For lifting capacity including bucket, subtract total weight of bucket or bucket and quickhitch from above values.
2. Lifting capacities are based on ISO 10567, that is: 75% of minimum tipping load or 87% of hydraulic lift capacity, whichever is the less. Lifting capacities marked* are based on hydraulic capacity.
3. Lift capacities assume that the machine is on firm, level ground.
4. Lift capacities may be limited by local regulations. Please refer to your dealer.



ONE COMPANY, OVER 300 MACHINES.

Your nearest JCB dealer



9999/5738 02/14 Issue 2 (T4i)

Hydraulic Excavator JS200/210/220/NLC/SC/LC

Engine Power: 129kW (173hp) Bucket Capacity: 0.4 – 1.19m³ Operating Weight: 19618– 22490kg

JCB Sales Limited, Rokester, Staffordshire, United Kingdom ST14 5JP.

Tel: +44 (0)1889 590312 Email: salesinfo@jcb.com

Download the very latest information on this product range at: www.jcb.com

©2009 JCB Sales. All rights reserved. No part of this publication may be reproduced, stored in a retrieval system, or transmitted in any form or by any other means, electronic, mechanical, photocopying or otherwise, without prior permission from JCB Sales. All references in this publication to operating weights, sizes, capacities and other performance measurements are provided for guidance only and may vary dependant upon the exact specification of machine. They should not therefore be relied upon in relation to suitability for a particular application. Guidance and advice should always be sought from your JCB Dealer. JCB reserves the right to change specifications without notice. Illustrations and specifications shown may include optional equipment and accessories. All images are correct at time of print. The JCB logo is a registered trademark of J.C. Bamford Excavators Ltd.

